



# HAND TOOLS





# Contents

- Cushion Grip Screwdrivers ..... 6 - 11
- MEGADORA Series ..... 11 - 14
- Plastic Grip Screwdrivers ..... 15 - 20
- Eco-friendly Screwdriver ..... 21 - 23
- Wooden Handle Screwdrivers ..... 24 - 25
- Non-Slip Screwdriver ..... 26 - 29
- Precision Screwdrivers ..... 30 - 33
- Functional Screwdrivers/  
Voltage Detection Screwdriver/Impact Driver ... 34 - 41
- Hex Wrenches/TORX Wrench  
TORX Screwdriver ..... 42 - 50
- For particular job unique tools ..... 51 - 55

HAND TOOLS

BITS & SOCKETS

ELECTRIC TOOLS

AIR TOOLS

STATIC SOLUTIONS

GASOLINE ENGINE TOOLS

## About ISO

### ISO 9001 : 2008

Our screwdriver manufacturing division, VESSEL SHIMANE CO., LTD is certified according to ISO standard, the global standard for quality assurance control.



### ISO 14001 : 2004

We obtained ISO 14001 in August 2010. VESSEL will further strive to offer eco-friendly products, aiming at minimizing the environmental burden as a manufacturing group.



# HAND TOOLS TECHNICAL

HAND TOOLS

BITS & SOCKETS

ELECTRIC TOOLS

AIR TOOLS

STATIC SOLUTIONS

GASOLINE ENGINE TOOLS

## Nominal designation based on shank types

**Cr-V steel**  
**Cr-V Mo steel**

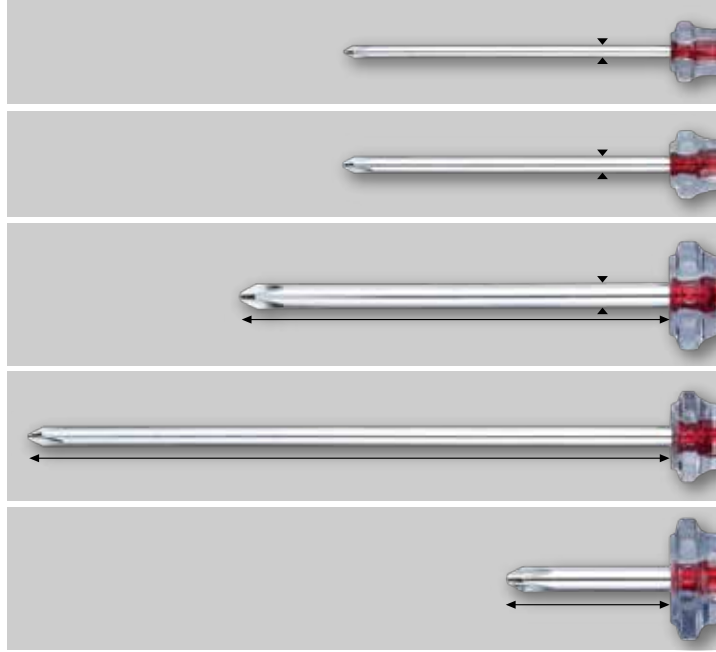

Good precision and durability nurtured in assembly lines Chrome vanadium steel that improves the shank strength

**Cr** (chromium): hardens the tip.  
**V** (vanadium): makes the tip tough.  
**Mo** (molybdenum): improves strength, hardness, and even toughness.

### Precision shank A shank diameter of 3 mm or less

This is for precision small screws whose thread diameter is 1 to 3 mm.

### Slim shank A diameter of 4 mm

This is a long slender shank to avoid interference even in a narrow area.

### Standard shank

It has a popular shank diameter and length based on various standards.

### Long shank

This is suitable for screw tightening in deep and narrow areas.

### Stubby shank

This is a short shank suitable for work in a confined area.

### Hexagon bolster

This part allows a spanner, etc. to be applied to retighten a screw or undo a hard-tightened screw.



### Magnetized Tip-End

The tip-end is strongly magnetized to capture screws for better work efficiency.

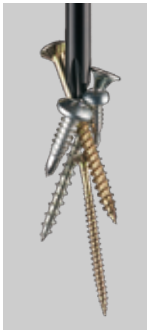

**JAWSFIT®**

### NEW JAWSFIT

Coated specially with high strength metallic granules. This prevents CAM-OUT (phenomenon peculiar to cross recessed screws).

### Black point®

The tip-end with the black oxide finishment is insensitive to the effect of a plating layer thickness and highly precise.





### General type

Type in which a shank is held in the handle. It is electrically safe.



### Tang-thru type

A shank is installed through the handle so that the screwdriver can be used for position adjustment or screw-hole correction by tapping the head with a hammer.



### CAUTION

Safety icons are printed and indicated for easy identification. (Displayed in a stepwise manner on a product basis)



### Cushion

An elastomer is integrally formed on the exterior of the grip. It provides elastic grip, offering large tightening force.

6P



### Ergonomics design

The use of design taking into account the shape of the palm and enhancing the operability at the finger tips ensures comfortable screw tightening.

11P  
15P  
21P



### Taper shape

Enabling a screwdriver to be easily taken out of a screwdriver holder. It is often used for screwdrivers related to electrical equipment.



### Wood handle

A long seller grip made of air-dried natural wood. It fits the palm of the hand as the tool is used longer.

24P

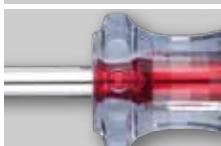

### Rolling prevention

Having a shape avoiding rolling over, which has also been widely adopted by overseas screwdrivers.



### Non-slip

VESSEL-developed non-slip surface features fine knurling process, enabling torque to be transmitted firmly even if there is oil on it.

26P



### Precision use

Designed to transmit a minute force efficiently. Intended for precision work

30P

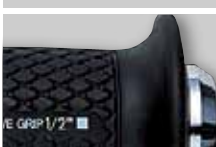

### Other functional grips

A ratchet screwdriver allowing screw tightening to be made by mere repetition of wrist movement; an impact screwdriver used to undo a rusted or stuck screw, etc.

34P



### Environmental Measures

Pb (lead) / Cd (cadmium) / Hg (mercury) / Hexavalent chromium / PBB (polybrominated biphenyl) / PBDE (polybrominated diphenyl ether) / DEHP, BBP, DBP, DIBP (phthalate esters)

The products with this mark in this catalogue are compliant with the RoHS directives (EU) (usage limit of the above 10 substances).

Note: For the updated information on RoHS compliant products, visit our homepage, because some products or sizes are under investigation or are not compliant at the time of publication of this catalogue.

No. 700

# Super Cushion Screwdriver



Highly elastic cushion grip.  
Fits the palm of the hand. No slipping.  
Transmits high torque to the tip.



A D V A N C E D  
**GEL-FUNCTION**  
T E C H N O L O G Y

**No. 700**  
**Super Cushion**  
**Screwdriver**

VESSEL Cushion Grip Screwdrivers fit not only screw heads but also your hand. This series assure the efficient torque transmission.

※The above illustration is for reference only.

HAND TOOLS

BITS & SOCKETS

ELECTRIC TOOLS

AIR TOOLS

STATIC SOLUTIONS

GASOLINE ENGINE TOOLS

### No. 700 Super Cushion Screwdriver

PAT.

- "Super Cushion" grip fits your hand perfectly.
- Rust-resistant black chrome plating.

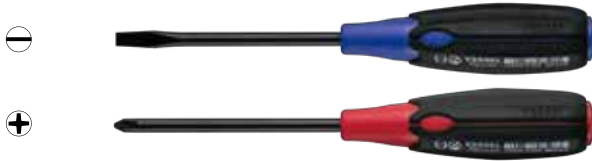

No.700	Bit						Inner Ctn.	Outer Ctn.	EDP No.
	⊖ 5.5 × 75	⊖ 6 × 100	⊖ 6 × 150	⊖ 8 × 150	⊕ 1 × 75	⊕ 2 × 100			
	5.5	0.8	75	5.5	29	182	6	120	125211
	6.0	0.9	100	6.4	32	215	6	120	125212
	6.0	0.9	150	6.4	32	265	6	120	125213
	8.0	1.1	150	8.0	34	275	6	120	125214
	⊕No.1	75	5.5	29	182		6	120	125215
	⊕No.2	100	6.4	32	215		6	120	125216
	⊕No.2	150	6.4	32	265		6	120	125217
	⊕No.3	150	8.0	34	275		6	120	125218

### No. 610 Cushion Grip Screwdriver (Thin Shank Type)

- Ideal for screw tightening in precision fields.
- Straight cut slotted tip good even for a use in cramped spaces.
- Highly precise black point tip, not being affected by the thickness of the plating layer.



No.610	Bit						Inner Ctn.	Outer Ctn.	EDP No.
	⊖ 4 × 75	⊖ 4 × 100	⊖ 4 × 150	⊖ 4 × 200	⊕ 00 × 75	⊕ 0 × 75			
	4.0	0.5	75	4.0	20.5	162	12	120	125332
	4.0	0.5	100	4.0	20.5	187	12	120	125333
	4.0	0.5	150	4.0	20.5	237	12	120	125335
	4.0	0.5	200	4.0	20.5	287	12	120	125336
	⊕No.00	75	4.0	20.5	162		12	120	125337
	⊕No.0	75	4.0	20.5	162		12	120	125339
	⊕No.0	100	4.0	20.5	187		12	120	125340
	⊕No.1	75	4.0	20.5	162		12	120	125341
	⊕No.1	100	4.0	20.5	187		12	120	125342
	⊕No.1	150	4.0	20.5	237		12	120	125343

### No. 720 Super Cushion Screwdriver (Stubby Type)

PAT.

- "Super Cushion" grip fits your hand perfectly.
- Rust-resistant black chrome plating.
- Ideal for working in cramped places.



No.720	Bit						Inner Ctn.	Outer Ctn.	EDP No.
	⊖ 6 × 15	⊕ 1 × 15	⊕ 2 × 15						
	6.0	0.9	15	6.0	35	68	6	120	125221
	⊕No.1	15	6.0	35	68		6	120	125222
	⊕No.2	15	6.0	35	68		6	120	125223

### No. 660 Cushion Grip Screwdriver (Stubby Type)

- With reversible blade (⊖5, ⊕2).

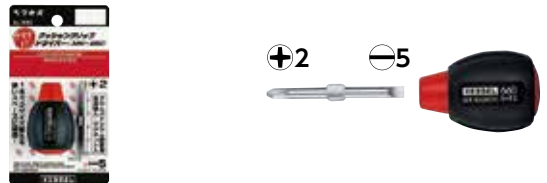

Set content		Package size (mm)	Inner Ctn.	Outer Ctn.	EDP No.
Grip	length 53mm dia. 35mm				
Reversible blade	⊖5 / ⊕2 × 60mm 1pc	135×75×35	10	60	133085

### No. 730 Super Cushion Tang-Thru Screwdriver

PAT.

- "Super Cushion" grip fits your hand perfectly.
- Tang-thru type with a star-shaped end cap for hammering.
- Rust-resistant black chrome plating.



No.730	Bit						Inner Ctn.	Outer Ctn.	EDP No.
	⊖ 5.5 × 75	⊖ 6 × 100	⊖ 6 × 150	⊖ 8 × 150	⊕ 1 × 75	⊕ 2 × 100			
	5.5	0.8	75	5.5	29	182	6	120	125231
	6.0	0.9	100	6.4	32	215	6	120	125232
	6.0	0.9	150	6.4	32	265	6	120	125233
	8.0	1.1	150	8.0	34	276	6	60	125234
	⊕No.1	75	5.5	29	182		6	120	125235
	⊕No.2	100	6.4	32	215		6	120	125236
	⊕No.2	150	6.4	32	265		6	120	125237
	⊕No.3	150	8.0	34	276		6	60	125238

### No. TD-110 Cushion 4-way Stubby Screwdriver

- Handle can store 2 types of double-ended bit with different tip end.

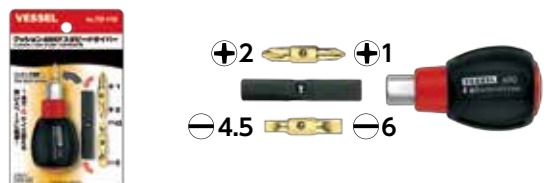

Set content		Package size (mm)	Inner Ctn.	Outer Ctn.	EDP No.
Grip	length 86mm dia. 35mm				
Reversible blade	⊕1 / ⊕2 × 35mm 1pc	135×85×35	10	60	251110
Holder	⊖4.5 / ⊖6 × 35mm 1pc				
Holder	1 pc				

**No. 220 Ball-Grip Screwdriver**

- Transmits ample tightening force to screw.
- Cushion grip color-coded by ⊕ ⊖.
- High precision black point tip.

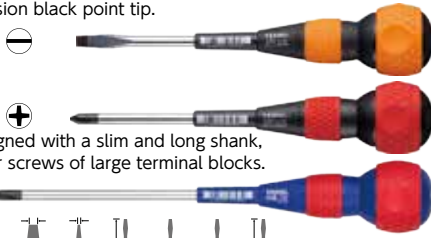

No.220	Tip	Tip (mm)	Inner Ctn.	Outer Ctn.	EDP No.	
⊖ 5.5x 75	5.5	0.8	75	5.5	32 156	6 60 125351
⊖ 5.5x 100	5.5	0.8	100	5.5	32 181	6 60 125361
⊖ 5.5x 150	5.5	0.8	150	5.5	32 231	6 60 125362
⊖ 6 x 100	6.0	0.9	100	6.4	41 200	6 60 125352
⊖ 6 x 150	6.0	0.9	150	6.4	41 250	6 60 125353
⊖ 6 x 200	6.0	0.9	200	6.4	41 300	6 60 125354
⊖ 6 x 300	6.0	0.9	300	6.4	41 400	6 60 125363
⊖ 8 x 150	8.0	1.1	150	6.4	41 250	6 60 125376
⊕ 1 x 75	⊕No.1	75	5.5	32	156	6 60 125355
⊕ 1 x 100	⊕No.1	100	5.5	32	181	6 60 125371
⊕ 1 x 150	⊕No.1	150	5.5	32	231	6 60 125372
⊕ 2 x 75	⊕No.2	75	5.5	32	156	6 60 125375
⊕ 2 x 100	⊕No.2	100	6.4	41	200	6 60 125356
⊕ 2 x 150	⊕No.2	150	6.4	41	250	6 60 125357
⊕ 2 x 200	⊕No.2	200	6.4	41	300	6 60 125358
⊕ 2 x 300	⊕No.2	300	6.4	41	400	6 60 125359
⊕ 3 x 150	⊕No.3	150	6.4	41	250	6 60 125374

**No. 220F Free-Turning Ball Grip Screwdriver (Screwdriver only)**

**PAT.**

- Free-turning hook enables fast turning.
- Elastomer resin excellently fits the hand.

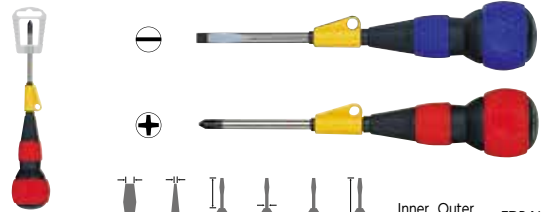

No.220F	Tip	Tip (mm)	Inner Ctn.	Outer Ctn.	EDP No.	
⊖ 6 x 100	6.0	0.9	100	6.4	41 200	6 60 125541
⊖ 6 x 150	6.0	0.9	150	6.4	41 250	6 60 125542
⊕ 2 x 100	⊕No.2	100	6.4	41	200	6 60 125543
⊕ 2 x 150	⊕No.2	150	6.4	41	250	6 60 125544

**No. 230 Ball-Grip Tang-Thru Screwdriver**

- Large nut for easy hammering.
- Transmits ample tightening force to screw.
- Cushion grip color-coded by ⊕ ⊖.
- High precision black point tip.



No.230	Tip	Tip (mm)	Inner Ctn.	Outer Ctn.	EDP No.	
⊖ 5.5x 75	5.5	0.8	75	5.5	32 156	6 60 125311
⊖ 6 x 100	6.0	0.9	100	6.4	41 200	6 60 125314
⊖ 6 x 150	6.0	0.9	150	6.4	41 250	6 60 125315
⊕ 1 x 75	⊕No.1	75	5.5	32	156	6 60 125321
⊕ 2 x 100	⊕No.2	100	6.4	41	200	6 60 125324
⊕ 2 x 150	⊕No.2	150	6.4	41	250	6 60 125325

**No. 225 Ball-Grip Screwdriver (With covered shank)**

- Resin-covered shank. It prevents electrical short circuit.
- Transmits ample tightening force to screw.
- Cushion grip is marked ⊕ ⊖ for quick identification.

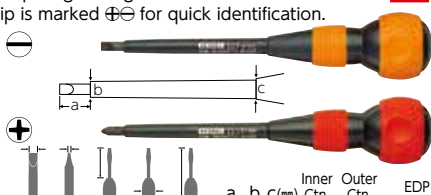

No.225	Tip	Tip (mm)	Inner Ctn.	Outer Ctn.	EDP No.	
⊖ 6 x 100	6.0	0.9	100	41	200 14 8 10	6 60 125382
⊖ 6 x 150	6.0	0.9	150	41	250 14 8 10	6 60 125383
⊕ 2 x 100	⊕No.2	100	41	200	14 8 10	6 60 125389
⊕ 2 x 150	⊕No.2	150	41	250	14 8 10	6 60 125390

⚠ Electric insulation is not guaranteed. For safety purposes, shut off power before use. The covered shaft protects against unexpected shorts. Should it become scratched, damaged or deteriorated, do not use the screwdriver.

**No. 200 Ball-Grip Insulated Screwdriver**

- High precision black point tip (black oxide finish)
- Easy identification of tip type by touching the end cap dent.



No.200	Tip	Tip (mm)	Inner Ctn.	Outer Ctn.	EDP No.	
⊖ 5 x 75	5.0	0.8	75	5	32 150	6 60 125841
⊖ 6 x 100	6.0	1.0	100	6	41 189	6 60 125842
⊖ 6 x 150	6.0	1.0	150	6	41 239	6 60 125843
⊕ 1 x 75	⊕No.1	75	5	32	150	6 60 125844
⊕ 2 x 100	⊕No.2	100	6	41	189	6 60 125845
⊕ 2 x 150	⊕No.2	150	6	41	239	6 60 125846
⊕ 3 x 150	⊕No.3	150	6	41	239	6 60 125847

**One point**

**Insulated Screwdrivers Series certified by VDE, International certification authority.**



**1000V AC, 1500V DC**



**1000V IEC60900**  
VDE is an authorized third-party certification organization.

**Reliable - 100% Energization (Dielectric) Inspection Conducted!**



For prevention of electric shock or short-circuit during electric works for power equipment, telecommunication devices, electric vehicles, solar power stations, and so on.

HAND TOOLS

BITS & SOCKETS

ELECTRIC TOOLS

AIR TOOLS

STATIC SOLUTIONS

GASOLINE ENGINE TOOLS



**No. 250 Tang-Thru Screwdriver w/Ceramic Ball (For electric works)**

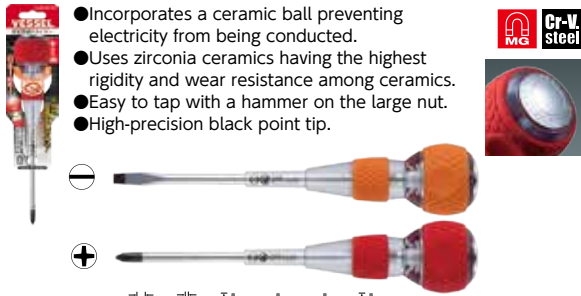

- Incorporates a ceramic ball preventing electricity from being conducted.
- Uses zirconia ceramics having the highest rigidity and wear resistance among ceramics.
- Easy to tap with a hammer on the large nut.
- High-precision black point tip.



No.250							Inner Ctn.	Outer Ctn.	EDP No.
⊖ 6 × 100	6.0	0.9	100	6.4	41	200	6	60	112105
⊖ 6 × 150	6.0	0.9	150	6.4	41	250	6	60	112106
⊖ 8 × 150	8.0	1.1	150	6.4	41	250	6	60	112109
⊕ 2 × 100	⊕No.2	100	6.4	41	200	6	60	112107	
⊕ 2 × 150	⊕No.2	150	6.4	41	250	6	60	112108	
⊕ 3 × 150	⊕No.3	150	6.4	41	250	6	60	112110	

**One point**

Tang-thru screwdriver No. 250 that incorporates a ceramic ball preventing electricity from being conducted



This is a screwdriver of new design in which a high-strength ceramic ball is sandwiched between the shank and nut. It can be used for various works of electrical and mechanical equipment as a screwdriver that can be "hit with a hammer and used for electricity-related work."

⚠ Electric insulation is not guaranteed. For safety purposes, shut off power before use.

**No. 220W Ball Grip (Bit-replaceable grip)**



- Compatibility with a 6.35mm hex drive bit enables to be used as a familiar ball grip screwdriver.

Model No.	Grip size	Package size (mm)	Outer Ctn.	EDP No.
220W	length 100mm, dia.41mm	145×50×43	10	125344

**No. 230W Ball Grip (Bit-replaceable Tang-Thru grip)**



- Blade interchangeable tang-thru grip. (A/F6.35mm)
- 25mm large nut incorporated transmitting well the hammering power.

Model No.	Grip size	Package size (mm)	Inner Ctn.	EDP No.
230W	length 100mm, dia.41mm	145×50×43	10	125326

**No. 270BW Cushion Stubby (Bit-replaceable grip)**

- Stubby type optimal for a narrow area. Compatibility with a 6.35mm hex drive bit for electric screwdrivers.



Model No.	Grip size	Package size (mm)	Outer Ctn.	EDP No.
270BW	length 55.5mm, dia.35mm	100×50×37	10	233074

**One point**

**Bit-replaceable grip**

Convenient grip can be used with various sizes of 6.35mm bit for electric screwdrivers.



⚠ Shut off power before use for safety purposes when using this product for electric works.



**No. B-640TX Cushion Grip TORX Screwdriver**

- Optimal for fastening screws in precision fields.
- Non-electrolytic plating, keeping the precise tip quality.
- Cushion grip fitting comfortably in a hand.
- Also good for tamper-proof TORX screws (except T5 and T6).

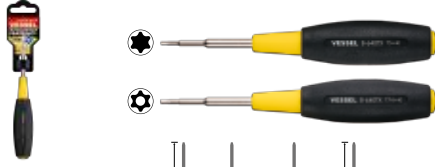

No. B-640TX	Bit	Length (mm)	Inner Ctn.	Outer Ctn.	EDP No.			
T5	1.42	40	4.0	20.5	126	6	60	123561
T6	1.69	40	4.0	20.5	126	6	60	123562
T7H	1.97	40	4.0	20.5	126	6	60	123563
T8H	2.30	40	4.0	20.5	126	6	60	123564
T9H	2.48	40	4.0	20.5	126	6	60	123565

TORX® is a registered trademark of Acument™ Intellectual Properties, LLC (USA). VESSEL has a manufacturing license in Japan and selling same to the world.

**No. 265 "NEON" Screwdriver**

- Glow-in-the-dark type.
- High precision black point tip.

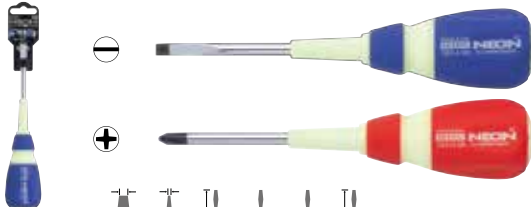

No. 265	Bit	Length (mm)	Inner Ctn.	Outer Ctn.	EDP No.				
⊖ 6× 100	6.0	0.9	100	6.4	40	185	6	60	125561
⊖ 6× 150	6.0	0.9	150	6.4	40	235	6	60	125562
⊕ 2× 100	⊕No.2	100	6.4	40	185	6	60	125563	
⊕ 2× 150	⊕No.2	150	6.4	40	235	6	60	125564	

**No. 2200 Ball Ratchet Screwdriver**

- With 36-teeth gear ratchet to realize comfortable operation with fine tuning.
- Shank cover prevents short circuits. Thin shank is convenient for operating on terminal blocks.
- Shank uses bit materials, fully hardened. Replacement shank is available as option.



No. 2200	Bit	Length (mm)	Inner Ctn.	Outer Ctn.	EDP No.				
⊖ 6× 100	6.0	0.8	100	6.0	41	200	6	60	125395
⊖ 6× 150	6.0	0.8	150	6.0	41	250	6	60	125396
⊕ 2× 100	⊕No.2	100	6.0	41	200	6	60	125345	
⊕ 2× 150	⊕No.2	150	6.0	41	250	6	60	125346	
⊕ 3× 150	⊕No.3	150	6.0	41	250	6	60	125347	

⚠ Electric insulation is not guaranteed. For safety purposes, shut off power before use.

**No. 2200B Ball Ratchet Screwdriver Replacement Blade**

- Shank uses bit materials, fully hardened.
- Replacement blade; can be replaced by pulling out the ball-grip part of No.2200.

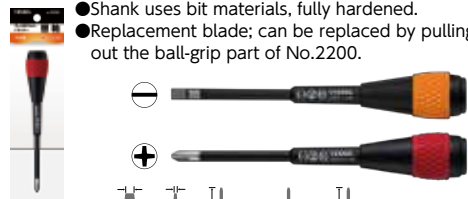

No. 2200B	Bit	Length (mm)	Inner Ctn.	Outer Ctn.	EDP No.			
⊖ 6× 100	6.0	0.8	100	6.0	158	6	60	125397
⊖ 6× 150	6.0	0.8	150	6.0	208	6	60	125398
⊕ 2× 100	⊕No.2	100	6.0	158	6	60	125348	
⊕ 2× 150	⊕No.2	150	6.0	208	6	60	125349	
⊕ 3× 150	⊕No.3	150	6.0	208	6	60	125350	

**No. SC-90 Anti-drop Slim Cord**

- Cord to prevent screwdrivers from dropping.
- Provided with a sleeve to avoid rings forming, which cause the cord to get caught.



Package content		Inner Ctn.	EDP No.
Mounted load	500g or less		
Length	482(maximum length 1500)mm	10	125405
Material	Sleeve: polypropylene Rubber band: polypropylene and natural rubber		

**One point**  
Move the sleeve to straighten the cord!

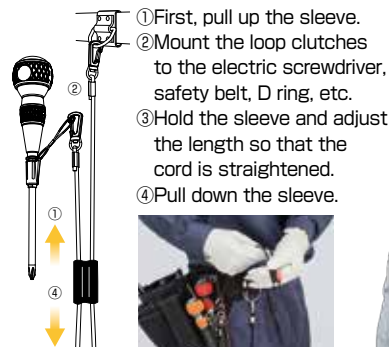

HAND TOOLS

BITS & SOCKETS

ELECTRIC TOOLS

AIR TOOLS

STATIC SOLUTIONS

GASOLINE ENGINE TOOLS

No. 980

# MEGADORA IMPACTA



Our proprietary Tang-thru nut incorporates cam rotation mechanism, which turns the driving tip counter-clockwise by 12 degrees when the handle is hit with a hammer.

IMPACTA leverages impact acceleration to remove stuck screws.



Adhered screw   Rusted screw   Stuck screw



**No. 980**

## MEGADORA IMPACTA

Equipped with a flat-surface grip and cushions on the corners of the hexagonal cross section. The inner core is a triple-layered construction using recycled resin, designed with practical use of resources.

※ The above illustration is for reference only.

HAND TOOLS

BITS & SOCKETS

ELECTRIC TOOLS

AIR TOOLS

STATIC SOLUTIONS

GASOLINE ENGINE TOOLS

**No. 980 MEGADORA IMPACTA PAT.**

- Tang-Thru nut with cam rotation mechanism.
- High precision black point tip.



No.980						Inner Ctn.	Outer Ctn.	EDP No.
⊕ 2 × 100	⊕No.2	100	6.4	34	213	6	60	125941
⊕ 2 × 150	⊕No.2	150	6.4	34	263	6	60	125942
⊕ 3 × 150	⊕No.3	150	8.0	36	278	6	60	125943

**No. 900 MEGADORA Standard Screwdriver PAT.**

- Philips JAWSFIT tip that firmly grips the screw. **JAWSFIT**
- Good for a work deep in a space. Useful for adjustment of automotive headlight and removal of a hose band.
- Junk (turning) grip minimizes shaking because of the long shank, to ensure stable tightening.



No.900						Inner Ctn.	Outer Ctn.	EDP No.	
⊖ 6 × 400	6.0	0.9	400	6.4	34	510	6	60	125709
⊕ 2 × 400	⊕No.2	400	6.4	34	510	6	60	125710	

**No. 900 MEGADORA Standard Screwdriver PAT.**

- NEW Philips JAWSFIT tip that firmly grips the screw. **JAWSFIT**
- A knurled shank is useful for fast and slipless turning by fingers and open wide holes on a wood material or a board.



No.900						Inner Ctn.	Outer Ctn.	EDP No.	
⊖ 5.5 × 75	5.5	0.8	75	5.5	30	175	6	60	125701
⊖ 6 × 100	6.0	0.9	100	6.4	34	210	6	60	125702
⊖ 6 × 150	6.0	0.9	150	6.4	34	260	6	60	125703
⊖ 8 × 150	8.0	1.1	150	8.0	36	275	6	60	125704
⊕ 1 × 75	⊕No.1	75	5.5	30	175	6	60	125705	
⊕ 2 × 100	⊕No.2	100	6.4	34	210	6	60	125706	
⊕ 2 × 150	⊕No.2	150	6.4	34	260	6	60	125707	
⊕ 3 × 150	⊕No.3	150	8.0	36	275	6	60	125708	

**No. 920 MEGADORA Stubby Screwdriver**

- Philips JAWSFIT tip that firmly grips the screw. **JAWSFIT**
- 25mm-long shank. Ideal for working in cramped places.

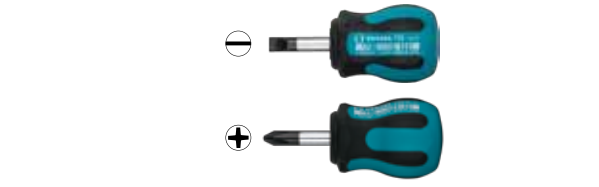

No.920						Inner Ctn.	Outer Ctn.	EDP No.	
⊖ 6 × 25	6.4	0.9	25	6.4	36	75	6	60	125752
⊕ 1 × 25	⊕No.1	25	6.4	36	75	6	60	125753	
⊕ 2 × 25	⊕No.2	25	6.4	36	75	6	60	125754	

**No. 910 MEGADORA Thin Shank Screwdriver**

- Precision type with 4 mm or smaller diameter shank.
- Black point tip, unaffected by the plating thickness.

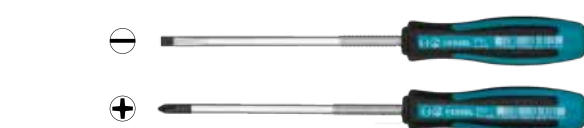

No.910						Inner Ctn.	Outer Ctn.	EDP No.	
⊖ 3 × 75	3.0	0.4	75	3.0	21	153	12	120	125746
⊖ 3 × 100	3.0	0.4	100	3.0	21	178	12	120	125747
⊖ 4 × 75	4.0	0.5	75	4.0	21	153	12	120	125748
⊖ 4 × 100	4.0	0.5	100	4.0	21	178	12	120	125749
⊖ 4 × 150	4.0	0.5	150	4.0	21	228	12	120	125750
⊖ 4 × 200	4.0	0.5	200	4.0	21	278	12	120	125751
⊕ 0 × 75	⊕No.0	75	3.0	21	153	12	120	125742	
⊕ 0 × 100	⊕No.0	100	3.0	21	178	12	120	125743	
⊕ 1 × 75	⊕No.1	75	4.0	21	153	12	120	125744	
⊕ 1 × 100	⊕No.1	100	4.0	21	178	12	120	125745	

**No. 930 MEGADORA Tang-Thru Screwdriver PAT.**

- NEW Philips JAWSFIT tip that firmly grips the screw. **JAWSFIT**
- Tang-Thru shank with large end cap.
- With a hexagonal bolster for spanner.



No.930							Inner Ctn.	Outer Ctn.	EDP No.	
⊖ 5.5 × 75	5.5	0.8	75	5.5	30	175	8	6	60	125711
⊖ 6 × 38	6.0	0.9	38	6.4	34	151	—	6	60	125719
⊖ 6 × 100	6.0	0.9	100	6.4	34	213	10	6	60	125712
⊖ 6 × 150	6.0	0.9	150	6.4	34	263	10	6	60	125713
⊖ 8 × 150	8.0	1.1	150	8.0	36	278	12	6	60	125714
⊕ 1 × 75	⊕No.1	75	5.5	30	175	8	6	60	125715	
⊕ 2 × 100	⊕No.2	100	6.4	34	213	10	6	60	125716	
⊕ 2 × 150	⊕No.2	150	6.4	34	263	10	6	60	125717	
⊕ 3 × 150	⊕No.3	150	8.0	36	278	12	6	60	125718	

HAND TOOLS

BITS & SOCKETS

ELECTRIC TOOLS

AIR TOOLS

STATIC SOLUTIONS

GASOLINE ENGINE TOOLS

### No. 970 MEGADORA Clip Remover **PAT.**

- One model for both large and small tips. Suited for many clips used with automobiles.
- Chrome plating, not causing scratches on a painted metal plate.
- Optimally angled for working in cramped spaces, such as, door trim, wire binding clip, and so on.

**Cr-V Steel**



No.970						Inner Ctn.	Outer Ctn.	EDP No.
CR × 120	12/7	120	7.0	34	230	6	60	125721

### No. 970 MEGADORA Chisel-Type Screwdriver **PAT.**

- Special steel for high quality cold chisel used. Hardness: 58HRC. Abrasion resistant and sharp edge.
- Elastomer-resin made grip absorbs shock when using and alleviate the fatigue on the hand.
- Tang-Thru shank with large end cap.

**Cr-V Mo Steel**



No.970							Inner Ctn.	Outer Ctn.	EDP No.
7 × 100	7.0	1.5	100	6	34	213	6	60	125722
9.5 × 120	9.5	1.7	120	8	36	248	6	60	125732

## One point

Pull out / Break



MEGADORA Clip Remover



Removing it by leverage

One model compatible with 2 popular types of clip in the automobile industry.

High-grade chisel used.



Sharp edge and anti-abrasion quality. Good for removal of welding on a spot, of burrs, and for various work with tiles and bricks.



MEGADORA Chisel-Type Screwdriver

### No. S-903 MEGADORA Pozidriv Screwdriver



- Dedicated to Pozidriv screws.
- VESSEL is an official licensee of Pozidriv.
- A knurled shank is useful for fast turning.



No.S-903						Inner Ctn.	EDP No.
PZ1× 75	PZ No.1	75	5.5	30	175	6	267254
PZ2× 100	PZ No.2	100	6.4	34	210	6	267255
PZ3× 150	PZ No.3	150	8.0	36	275	6	267256

**No. 960 MEGADORA Insulated Screwdriver NEW**

- Insulated Screwdrivers Series certified by VDE (IEC60900), International certification authority.
- Safe and secured double insulation layer.
- Highly precise tip-end (black oxide finish).
- Chrome-vanadium steel, fully hardened. ● Flat Surface Grip.

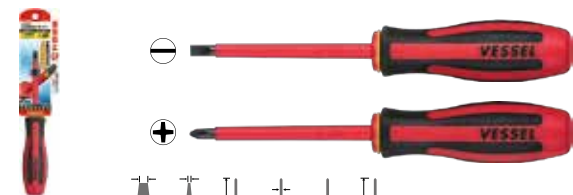

No.960	Inner Ctn.	Outer Ctn.	EDP No.
⊖ 0.8 x 5 x 75	5.0	0.8	75
⊖ 1.0 x 6 x 100	6.0	1.0	100
⊖ 1.2 x 8 x 150	8.0	1.2	150
⊕ 1 x 75	5.0	0.8	75
⊕ 2 x 100	6.0	1.0	100
⊕ 3 x 150	8.0	1.2	150

# One point

For protection against electric shock

Insulated Screwdrivers Series certified by VDE, International certification authority.

1000V AC or less, 1500V DC or less



VDE is an authorized third-party certification organization.



Safe and secured double insulation layer

Reliable - 100% Energization (Dielectric) Inspection Conducted!



For prevention of electric shock, short-circuit during electric works for power equipment, and so on.



**⚠ WARNING!**

- STOP IMMEDIATELY using this screwdriver when the yellow shank cover comes out or there is a damage or alike on the product.
- NEVER USE FOR HOT-LINE JOB, RISQUE OF ELECTRICAL SHOCK.

**No. 960PS MEGADORA Insulated Screwdriver NEW**

- Insulated Screwdrivers Series certified by VDE (IEC60900), International certification authority.
- Safe and secured double insulation layer.
- Highly precise tip-end (black oxide finish).
- Chrome-vanadium steel, fully hardened. ● Flat Surface Grip.



No.960PS	Inner Ctn.	Outer Ctn.	EDP No.
PS2 x 100	PS2	100	7.8
PS3 x 150	PS3	150	9.8

HAND TOOLS

BITS & SOCKETS

ELECTRIC TOOLS

AIR TOOLS

STATIC SOLUTIONS

GASOLINE ENGINE TOOLS

No. 6300

# "CRYSTALLINE" Screwdriver



We have created a colorful grip with a crystalline sparkle. We offer an abundant lineup of shank sizes, including those capable of accessing deeply recessed or narrow areas.



**No. 6300**  
**"CRYSTALLINE"**  
**Screwdriver**

Uses cellulose acetate resin with good oil and chemical resistance. Uses raw materials such as wood and cotton (literal meaning of cellulose).

**No. 6300 "CRYSTALINE" Screwdriver PAT.**

- Bright quartz "CRYSTALINE" handles. Color coding by  $\oplus$ / $\ominus$ .
- Uses cellulose acetate resin.

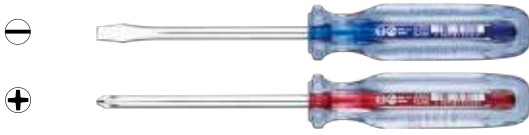

No.6300								Inner Ctn.	Outer Ctn.	EDP No.
		(mm)								
$\ominus$ 4.5 × 50	4.5	0.6	50	5.0	22.0	138	12	240	121201	
$\ominus$ 5.5 × 75	5.5	0.8	75	5.5	22.0	163	12	240	121202	
$\ominus$ 6 × 100	6.0	0.9	100	6.0	26.5	205	12	240	121203	
$\ominus$ 8 × 150	8.0	1.1	150	8.0	28.5	263	12	120	121205	
$\ominus$ 9 × 200	9.0	1.2	200	9.0	28.5	313	6	60	121206	
$\ominus$ 10 × 250	10.0	1.2	250	9.0	28.5	363	6	60	121207	
$\ominus$ 10 × 300	10.0	1.2	300	9.0	28.5	413	6	60	121208	
$\oplus$ 1 × 75	$\oplus$ No.1	75	5.0	22.0	163		12	240	121209	
$\oplus$ 2 × 100	$\oplus$ No.2	100	6.0	26.5	205		12	240	121210	
$\oplus$ 3 × 150	$\oplus$ No.3	150	8.0	28.5	263		12	120	121211	
$\oplus$ 4 × 200	$\oplus$ No.4	200	9.0	28.5	313		6	60	121212	

**No. 6300E "CRYSTALINE" Screwdriver NEW PAT.**

- Bright quartz "CRYSTALINE" handles. Color coding by  $\oplus$ / $\ominus$ .
- Uses cellulose acetate resin.
- Large handle for even better operatability.



No.6300E								Inner Ctn.	Outer Ctn.	EDP No.
		(mm)								
$\ominus$ 5 × 150	5.0	0.8	150	5.0	26.5	255	12	120	121254	
$\ominus$ 5 × 200	5.0	0.8	200	5.0	26.5	305	12	120	121255	
$\ominus$ 5 × 250	5.0	0.8	250	5.0	26.5	355	12	120	121256	
$\oplus$ 1 × 150	$\oplus$ No.1	150	5.0	26.5	255		12	120	121257	
$\oplus$ 1 × 200	$\oplus$ No.1	200	5.0	26.5	305		12	120	121258	
$\oplus$ 1 × 250	$\oplus$ No.1	250	5.0	26.5	355		12	120	121259	

**One point**

The dia. **26.5** mm handle model newly available for overseas market!

More comfortable to hold and more convenient to tighten screws. Larger handle than our conventional 22mm model.

**Conventional Model**

No.6300

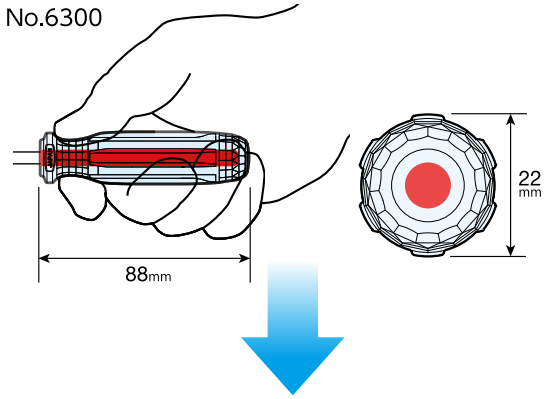

**New Model**

No.6300E

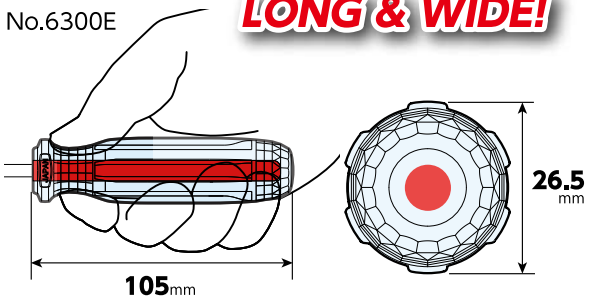

**LONG & WIDE!**

**No. 6300 "CRYSTALINE" Screwdriver (Long Shank Type) PAT.**

- Bright quartz "CRYSTALINE" handle. Marked for  $\oplus$ / $\ominus$ .
- Long shank for fastening in a hard-to-reach space.
- Uses cellulose acetate resin.



No.6300								Inner Ctn.	Outer Ctn.	EDP No.
		(mm)								
$\ominus$ 5 × 150	5.0	0.8	150	5.0	22	238	12	120	121213	
$\ominus$ 5 × 200	5.0	0.8	200	5.0	22	288	12	120	121214	
$\ominus$ 5 × 250	5.0	0.8	250	5.0	22	338	12	120	121215	
$\oplus$ 1 × 150	$\oplus$ No.1	150	5.0	22	238		12	120	121216	
$\oplus$ 1 × 200	$\oplus$ No.1	200	5.0	22	288		12	120	121217	
$\oplus$ 1 × 250	$\oplus$ No.1	250	5.0	22	338		12	120	121218	
$\oplus$ 2 × 150	$\oplus$ No.2	150	6.0	26.5	255		12	120	121219	
$\oplus$ 2 × 200	$\oplus$ No.2	200	6.0	26.5	305		12	120	121220	
$\oplus$ 2 × 250	$\oplus$ No.2	250	6.0	26.5	355		12	120	121221	

HAND TOOLS

BITS & SOCKETS

ELECTRIC TOOLS

AIR TOOLS

STATIC SOLUTIONS

GASOLINE ENGINE TOOLS



### No. 6100 "CRYSTALINE" Screwdriver (Thin Shank Type)

PAT.

- Bright quartz "CRYSTALINE" handle. Marked for ⊕⊖.
- Thin shank screwdriver. Ideal for working in cramped spaces.
- Uses cellulose acetate resin.



No.6100							Inner Ctn.	Outer Ctn.	EDP No.
⊖ 4 × 50	4.0	0.45	50	4	16	124.5	12	240	121001
⊖ 4 × 75	4.0	0.45	75	4	16	149.5	12	240	121002
⊖ 4 × 100	4.0	0.45	100	4	16	174.5	12	240	121003
⊖ 4 × 150	4.0	0.45	150	4	16	224.5	12	120	121005
⊖ 4 × 200	4.0	0.45	200	4	16	274.5	12	120	121006
⊕ 0 × 75	⊕No.0	75	4	16	149.5		12	240	121323
⊕ 0 × 100	⊕No.0	100	4	16	174.5		12	240	121009
⊕ 0 × 150	⊕No.0	150	4	16	224.5		12	120	121325
⊕ 0 × 200	⊕No.0	200	4	16	274.5		12	120	121326
⊕ 1 × 75	⊕No.1	75	4	16	149.5		12	240	121008
⊕ 1 × 100	⊕No.1	100	4	16	174.5		12	240	121012
⊕ 1 × 150	⊕No.1	150	4	16	224.5		12	120	121013
⊕ 1 × 200	⊕No.1	200	4	16	274.5		12	120	121014
⊕ 2 × 200	⊕No.2	200	4	16	274.5		12	120	121015
⊕ 2 × 250	⊕No.2	250	4	16	324.5		12	120	121016

### No. 6200 "CRYSTALINE" Screwdriver (Stubby Type)

PAT.

- Bright quartz "CRYSTALINE" handle. Marked for ⊕⊖.
- Ideal for working in cramped spaces.
- Uses cellulose acetate resin.



No.6200							Inner Ctn.	Outer Ctn.	EDP No.
⊖ 6 × 38	6.0	0.9	38	6	30	87.5	12	240	121101
⊕ 1 × 38	⊕No.1	38	6	30	87.5		12	240	121102
⊕ 2 × 38	⊕No.2	38	6	30	87.5		12	240	121103

### No. 6900 "CRYSTALINE" Screwdriver (Precision Type)

PAT.

- Bright quartz "CRYSTALINE" handle. Marked for ⊕⊖.
- For intense precision work.
- Handle butt is recessed to allow pressing with fingertips for fast turning.
- Uses cellulose acetate resin.



No.6900							Inner Ctn.	Outer Ctn.	EDP No.
⊖ 2.5 × 50	2.5	0.35	50	3	14	101	24	240	121301
⊖ 2.5 × 75	2.5	0.35	75	3	14	126	24	240	121302
⊖ 2.5 × 100	2.5	0.35	100	3	14	151	24	240	121303
⊕ 00 × 50	⊕No.00	50	3	14	101		24	240	121327
⊕ 0 × 75	⊕No.0	75	3	14	126		24	240	121304

### No. 6603 Long Square Shank Screwdriver PAT.

- 450mm-long square shank. Fully hardened tough special steel.
- Effective with high strength tightening.
- For fastening screws of sanitary appliances, etc.
- Uses cellulose acetate resin.



No.6603							Outer Ctn.	EDP No.	
⊖ 9 × 450	9.0	1.2	450	8	113	28.5	563	6	122231
⊕ 2 × 450	⊕No.2	450	6	113	28.5	563		6	122232
⊕ 3 × 450	⊕No.3	450	8	113	28.5	563		6	122233

## One point

### An Eco-friendly grip made from plant-based ingredients

Cellulose acetate resin, used in many plastic screwdrivers, is once again in the spotlight as an ecologically friendly plant-based polyester resin. Cellulose acetate resin is an outstanding material that is resistant to oil, chemicals, and shock.

As the word cellulose implies, the grip is made from wood pulp and cotton.

This resin grip is ecologically friendly with a low environment load, and does not upset the CO2 balance when burned.



**B-370** **Mini-Grip Long-Term Screwdriver**

• Ergonomically designed plastic handle  
 • Long-term use  
 • Available in 10 different sizes  
 • Available in 10 different colors

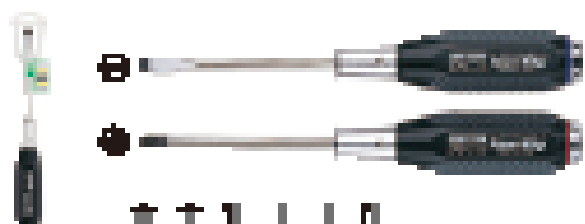

Size	Bit	Length	Weight	Material	Color
#1	PH	100	10g	Stainless Steel	Black
#2	PH	120	12g	Stainless Steel	Black
#3	PH	140	14g	Stainless Steel	Black
#4	PH	160	16g	Stainless Steel	Black
#5	PH	180	18g	Stainless Steel	Black
#6	PH	200	20g	Stainless Steel	Black
#7	PH	220	22g	Stainless Steel	Black
#8	PH	240	24g	Stainless Steel	Black
#9	PH	260	26g	Stainless Steel	Black
#10	PH	280	28g	Stainless Steel	Black

**4600** **Power-Grip Screwdriver**

• Ergonomically designed plastic handle  
 • Long-term use  
 • Available in 10 different sizes  
 • Available in 10 different colors



Size	Bit	Length	Weight	Material	Color
#1	PH	100	10g	Stainless Steel	Blue
#2	PH	120	12g	Stainless Steel	Blue
#3	PH	140	14g	Stainless Steel	Blue
#4	PH	160	16g	Stainless Steel	Blue
#5	PH	180	18g	Stainless Steel	Blue
#6	PH	200	20g	Stainless Steel	Blue
#7	PH	220	22g	Stainless Steel	Blue
#8	PH	240	24g	Stainless Steel	Blue
#9	PH	260	26g	Stainless Steel	Blue
#10	PH	280	28g	Stainless Steel	Blue

**4500** **Power-Grip Screwdriver**

• Ergonomically designed plastic handle  
 • Long-term use  
 • Available in 10 different sizes  
 • Available in 10 different colors



Size	Bit	Length	Weight	Material	Color
#1	PH	100	10g	Stainless Steel	Red
#2	PH	120	12g	Stainless Steel	Red
#3	PH	140	14g	Stainless Steel	Red
#4	PH	160	16g	Stainless Steel	Red
#5	PH	180	18g	Stainless Steel	Red
#6	PH	200	20g	Stainless Steel	Red
#7	PH	220	22g	Stainless Steel	Red
#8	PH	240	24g	Stainless Steel	Red
#9	PH	260	26g	Stainless Steel	Red
#10	PH	280	28g	Stainless Steel	Red

**4100** **Power-Stacked Screwdriver**

• Ergonomically designed plastic handle  
 • Long-term use  
 • Available in 10 different sizes  
 • Available in 10 different colors

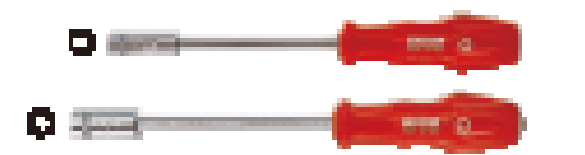

Size	Bit	Length	Weight	Material	Color
#1	PH	100	10g	Stainless Steel	Red
#2	PH	120	12g	Stainless Steel	Red
#3	PH	140	14g	Stainless Steel	Red
#4	PH	160	16g	Stainless Steel	Red
#5	PH	180	18g	Stainless Steel	Red
#6	PH	200	20g	Stainless Steel	Red
#7	PH	220	22g	Stainless Steel	Red
#8	PH	240	24g	Stainless Steel	Red
#9	PH	260	26g	Stainless Steel	Red
#10	PH	280	28g	Stainless Steel	Red

**5400T** **Power-Grip Torx Screwdriver**

• Ergonomically designed plastic handle  
 • Long-term use  
 • Available in 10 different sizes  
 • Available in 10 different colors



Size	Bit	Length	Weight	Material	Color
T 8	TORX	100	10g	Stainless Steel	Yellow
T 9	TORX	120	12g	Stainless Steel	Yellow
T 10	TORX	140	14g	Stainless Steel	Yellow
T 11	TORX	160	16g	Stainless Steel	Yellow
T 12	TORX	180	18g	Stainless Steel	Yellow
T 13	TORX	200	20g	Stainless Steel	Yellow
T 14	TORX	220	22g	Stainless Steel	Yellow
T 15	TORX	240	24g	Stainless Steel	Yellow
T 16	TORX	260	26g	Stainless Steel	Yellow
T 17	TORX	280	28g	Stainless Steel	Yellow

**B-5400BP** **Power-Grip Universal Screwdriver**

• Ergonomically designed plastic handle  
 • Long-term use  
 • Available in 10 different sizes  
 • Available in 10 different colors



Size	Bit	Length	Weight	Material	Color
H 1	HEX	100	10g	Stainless Steel	Purple
H 2	HEX	120	12g	Stainless Steel	Purple
H 3	HEX	140	14g	Stainless Steel	Purple
H 4	HEX	160	16g	Stainless Steel	Purple
H 5	HEX	180	18g	Stainless Steel	Purple
H 6	HEX	200	20g	Stainless Steel	Purple

HAND TOOLS

BITS & SOCKETS

ELECTRIC TOOLS

AIR TOOLS

STATIC SOLUTIONS

GASOLINE ENGINE TOOLS

**TD-350Y / 230B / 340G 3-Point Screwdriver**

Standard impact body, 3-point design, 3-point design, 3-point design



Model	Material	Material	Size	Price
TD-350Y	6061-T6 Aluminum	100mm	10	34000
TD-230B	6061-T6 Aluminum	100mm	10	34000
TD-340G	6061-T6 Aluminum	100mm	10	34000

**TD-310 3-Point Cross Screwdriver**

Standard impact body, 3-point design, 3-point design, 3-point design

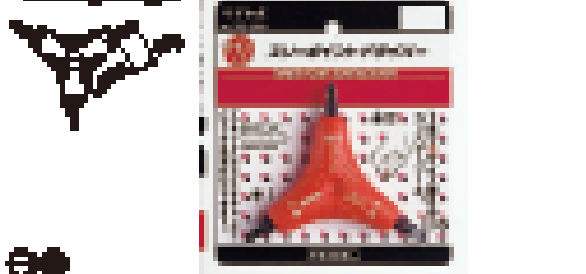

Model	Material	Material	Size	Price
TD-310	6061-T6 Aluminum	100mm	10	34000

**TD-6310HX Mini Screwdriver Set**

Standard impact body, 3-point design, 3-point design, 3-point design

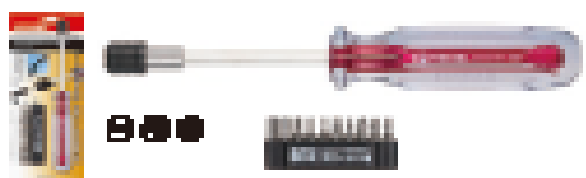

Model	Material	Material	Size	Price
TD-6310HX	6061-T6 Aluminum	100mm	10	34000

**TD-6310TX Mini Screwdriver Set**

Standard impact body, 3-point design, 3-point design, 3-point design



Model	Material	Material	Size	Price
TD-6310TX	6061-T6 Aluminum	100mm	10	34000

**TD-1342 / 28 13mm Hex Key Set**

Standard impact body, 3-point design, 3-point design, 3-point design

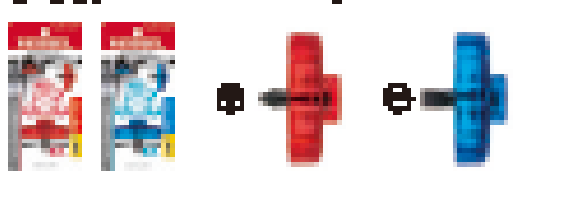

Model	Material	Material	Size	Price
TD-1342 / 28	6061-T6 Aluminum	100mm	10	34000

**TD-1344 / 34S 13mm Hex Key Set**

Standard impact body, 3-point design, 3-point design, 3-point design

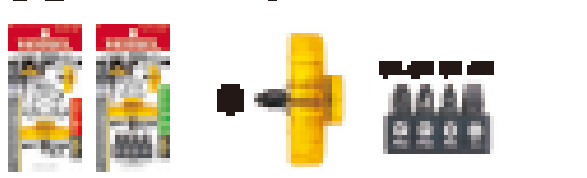

Model	Material	Material	Size	Price
TD-1344 / 34S	6061-T6 Aluminum	100mm	10	34000

HAND TOOLS

BITS & SOCKETS

ELECTRIC TOOLS

AIR TOOLS

STATIC SOLUTIONS

GASOLINE ENGINE TOOLS

**No. TD-410 "FAMIDORA" Reversible Blade Screwdriver**

- Ergonomic handle that fits in the palm of the hand.
- Fully hardened shank. Tough tip.



Set content		Package size (mm)	Inner Ctn.	Outer Ctn.	EDP No.
Handle	length 101.5mm dia. 29mm				
Driver blades	Φ2 / Φ6×150mm	185×75×31	10	60	251801

**No. TD-2100 "Dual-Tone" Screwdriver Set**

- Set of a handle and interchangeable blades, convenient for repair/ disassembly of electric goods, toys, and equipment instruments.
- Octagonal grip effectively transmitting fastening force; made of polypropylene, oil and chemical resistant.
- Blades have a thin non-electrolytic plating layer and fits screws.
- Magnetized tip catching screws. ●Provided with a handy bag.



Set content		Package size (mm)	Inner Ctn.	EDP No.
Handle	length 100mm dia. 30mm			
Driver blades	Φ1, Φ2, Φ4, Φ6×120mm	126×64×35	40	247030

**No. TD-912N "FAMIDORA 12" Screwdriver 12-Piece Set**

- Ergonomic handle that fits in the palm of the hand.
- Color-coded interchangeable driver blades.
- Provided with a screwdriver stand, which is convenient for storage.



Set content		Package size (mm)	Inner Ctn.	Outer Ctn.	EDP No.
Handle	length 100mm dia. 29.5mm				
Driver blades	Φ0, Φ1, Φ2, Φ2.5, Φ4, Φ6, Awl, Pin extractor×128mm	160×150×35	10	60	251800

**One point**

**Features of the FAMIDORA series**  
Small handle / Big handle

Compact design useful as a standing set in households, offices, stores, etc.

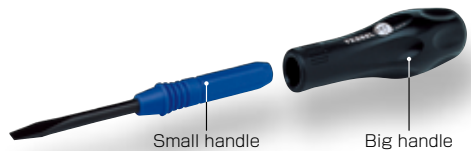

Without big handle, the screwdriver can be used.

**No. TD-800 "FAMIDORA 8" Screwdriver 8-Piece Set**

- Ergonomic handle that fits in the palm of the hand.
- Color-coded interchangeable driver blades.
- Provided with a screwdriver stand, which is convenient for storage.



Set content		Package size (mm)	Inner Ctn.	Outer Ctn.	EDP No.
Handle	length 100mm dia. 29.5mm				
Driver blades	Φ0, Φ1, Φ2, Φ2.5, Φ4, Φ6, Awl, Pin extractor×128mm	160×150×35	10	60	251800



In a drawer



In a gap beside a cash register



For mounting hardware



For fastening a sign with screws

HAND TOOLS

BITS & SOCKETS

ELECTRIC TOOLS

AIR TOOLS

STATIC SOLUTIONS

GASOLINE ENGINE TOOLS

No. 550

# "SEPADORA" Screwdriver



Environmentally friendly products with low environmental impacts are desired in corporate activities.  
All are ecological when held by hand.



Elastomer wrapping the grip holds the shank.



**No. 550**  
**"SEPADORA" Screwdriver**

Eco screwdrivers of the special manufacturing process that enables the shank and the handle to be separated.  
The ergonomic grip designed in the motif of a leaf is superior in tightening force.

**⚠ Caution (SEPADORA)**

● Eco screwdrivers are not tang-thru screwdrivers; hitting a screwdriver with a hammer disables the shank from being pulled out or causes it to be deformed or broken.

※ The above illustration is for reference only.

**No.550 "SEPADORA" Screwdriver PAT.**

- Shank and grip are separable. Sort and recycle.
- Wavy octagonal grip fits your palm and transmits driving torque effectively.



←See P21

No.550							Inner Ctn.	Outer Ctn.	EDP No.
⊖ 5.5 × 75	5.5	0.8	75	5.0	30.0	175	6	120	121601
⊖ 6 × 100	6.0	0.9	100	6.0	33.5	210	6	60	121602
⊖ 8 × 150	8.0	1.1	150	8.0	36.0	275	6	60	121603
⊕ 1 × 75	⊕No.1	75	5.0	30.0	175		6	120	121611
⊕ 2 × 100	⊕No.2	100	6.0	33.5	210		6	60	121612
⊕ 2 × 150	⊕No.2	150	6.0	33.5	260		6	60	121613
⊕ 3 × 150	⊕No.3	150	8.0	36.0	275		6	60	121616

**No.590 "SEPADORA" Screwdriver (Precision Type) PAT.**

- Shank and grip are separable. Sort and recycle.
- Wavy octagonal grip fits your palm and transmits driving torque effectively.
- Special grip with a clip.
- Thin shank screwdriver. Ideal for screw tightening in precision fields.
- ※⌀00x50 is with a fully black oxide finish shank.



No.590							Inner Ctn.	Outer Ctn.	EDP No.
⊖ 2.5 × 50	2.5	0.35	50	3.0	15.4	99	24	480	121671
⊖ 2.5 × 75	2.5	0.35	75	3.0	15.4	124	24	480	121672
⊖ 2.5 × 100	2.5	0.35	100	3.0	15.4	149	24	480	121673
⊕ 00 × 50	⊕No.00	50	3.0	15.4	99		24	480	121674
⊕ 0 × 75	⊕No.0	75	3.0	15.4	124		24	480	121675

**No.560 "SEPADORA" Screwdriver (Thin Shank Type) PAT.**

- Shank and grip are separable. Sort and recycle.
- Wavy octagonal grip fits your palm and transmits driving torque effectively.
- Thin shank screwdriver. Ideal for screw tightening in narrow spaces.



No.560							Inner Ctn.	Outer Ctn.	EDP No.
⊖ 4 × 75	4.0	0.5	75	4.0	19.8	153	12	240	121632
⊖ 4 × 100	4.0	0.5	100	4.0	19.8	178	12	240	121633
⊖ 4 × 150	4.0	0.5	150	4.0	19.8	228	12	240	121634
⊖ 4 × 200	4.0	0.5	200	4.0	19.8	278	12	240	121635
⊕ 0 × 75	⊕No.0	75	4.0	19.8	153		12	240	121642
⊕ 1 × 100	⊕No.1	100	4.0	19.8	178		12	240	121647
⊕ 2 × 150	⊕No.2	150	4.0	19.8	228		12	240	121651

**No.570 "SEPADORA" Screwdriver (Stubby Type) PAT.**

- Shank and grip are separable. Sort and recycle.
- Wavy octagonal grip fits your palm and transmits driving torque effectively.
- Ideal for working in cramped places.



No.570							Inner Ctn.	Outer Ctn.	EDP No.
⊖ 6 × 25	6.0	0.9	25	6.0	45	50	12	240	121661
⊕ 1 × 25	⊕No.1	25	6.0	45	50		12	240	121662
⊕ 2 × 25	⊕No.2	25	6.0	45	50		12	240	121663

One point

Concave octagonal grip

Dents and projections of the waves fit into your palm to transmit the torque securely.



Black point processing

High precision finish, unaffected by plate thickness

Rust-proof chrome plating

Elastomer grip

The elastomer resin coating on the surface is slip-proof and fits into your palm

Tip shape is shown on the grip end

HAND TOOLS

BITS & SOCKETS

ELECTRIC TOOLS

AIR TOOLS

STATIC SOLUTIONS

GASOLINE ENGINE TOOLS

### No.500 ECO VALUE Screwdriver

- Robust looking black hard grip.
- Wavy octagonal grip fits your palm and transmits driving torque effectively.
- Champagne gold plating, keeping the precise tip quality.



No.500							Inner Ctn.	Outer Ctn.	EDP No.
⊖ 5.5 × 75	5.5	0.8	75	5.0	30.0	175	6	120	121751
⊖ 6 × 100	6.0	0.9	100	6.0	33.5	210	6	60	121752
⊖ 8 × 150	8.0	1.1	150	8.0	36.0	275	6	60	121753
⊕ 1 × 75	⊕No.1	75	5.0	30.0	175		6	120	121761
⊕ 2 × 100	⊕No.2	100	6.0	33.5	210		6	60	121762
⊕ 3 × 150	⊕No.3	150	8.0	36.0	275		6	60	121766

\*The shank is not separable.

### No.510 ECO VALUE Screwdriver

- Robust looking black hard grip.
- Wavy octagonal grip fits your palm and transmits driving torque effectively.
- Thin shank screwdriver. Ideal for screw tightening in narrow spaces.
- Champagne gold plating, keeping the precise tip quality.



No.510							Inner Ctn.	Outer Ctn.	EDP No.
⊖ 4 × 75	4.0	0.45	75	4.0	19.8	153	12	240	121782
⊖ 4 × 100	4.0	0.45	100	4.0	19.8	178	12	240	121783
⊕ 0 × 75	⊕No.0	75	4.0	19.8	153		12	240	121792
⊕ 1 × 100	⊕No.1	100	4.0	19.8	178		12	240	121797

\*The shank is not separable.

### No.540 ECO VALUE Screwdriver (Precision Type)

- Robust looking black hard grip.
- Wavy octagonal grip fits your palm and transmits driving torque effectively.
- Special grip with a clip.
- Thin shank screwdriver. Ideal for screw tightening in precision fields.
- Champagne gold plating, keeping the precise tip quality.



No.540							Inner Ctn.	Outer Ctn.	EDP No.
⊖ 2.5 × 50	2.5	0.35	50	3.0	15.4	99	24	480	121821
⊕ 00 × 50	⊕No.00	50	3.0	15.4	99		24	480	121824
⊕ 0 × 75	⊕No.0	75	3.0	15.4	124		24	480	121825

\*The shank is not separable.

### No.520 ECO VALUE Screwdriver (Stubby Type)

- Robust looking black hard grip.
- Wavy octagonal grip fits your palm and transmits driving torque effectively.
- Ideal for working in cramped spaces.
- Champagne gold plating, keeping the precise tip quality.



No.520							Inner Ctn.	Outer Ctn.	EDP No.
⊖ 6 × 25	6.0	0.9	25	6.0	45	50	12	240	121811
⊕ 1 × 25	⊕No.1	25	6.0	45	50		12	240	121812
⊕ 2 × 25	⊕No.2	25	6.0	45	50		12	240	121813

\*The shank is not separable.

### No.460NT-9S ECOSOFT T-bar screwdriver (w/socket bit set)

- The ergonomic grip fits comfortably in your hand. T-shaped handle transmits high torque without applying too much force by your hand.
- Ball-lock type holds a socket assuredly. Hex drive 6.35mm.



Set content		Package size (mm)	Inner Ctn.	Outer Ctn.	EDP No.
Body	length 165.5mm dia. 100mm				
Socket bits	A/F5, A/F5.5, A/F6, A/F7, A/F8, A/F9, A/F10, A/F12, A/F13 x26.5mm	235x120x30	5	30	121891
Accessories	Socket bit holder				

\*The shank is not separable.

No. 100

# Powerful Tang-Thru Screwdriver



Luxurious furniture finish coating on the large handle, which fits more comfortably in your hand the more you use it.

Its better usability compared to plastic handles attracts support from many professional users.



**No. 100**

## Powerful Tang-Thru Screwdriver

Especially large, heavy-duty end cap. An especially large end cap efficiently delivers the shock of the hammer blow.

When tapped with a hammer, and adjusting the force of the tapping to the condition of the material concerned, this screwdriver can be used effectively to loosen stripped or rusted screws.

※The above illustration is for reference only.

HAND TOOLS

BITS & SOCKETS

ELECTRIC TOOLS

AIR TOOLS

STATIC SOLUTIONS

GASOLINE ENGINE TOOLS



### No. 100 Powerful Tang-Thru Screwdriver

- Wooden handle and Tang-Thru shank with thick end cap.
- Large and long grip comfortable to hold.
- Black point tip.



No.100							Inner Ctn.	Outer Ctn.	EDP No.
⊖ 5.5 × 75	5.5	0.8	75	5.8	27.0	182	6	120	111051
⊖ 6 × 100	6.0	0.9	100	6.4	30.5	223	6	120	111052
⊖ 6 × 300	6.0	0.9	300	6.4	30.5	423	6	60	111061
⊖ 8 × 150	8.0	1.1	150	8.0	34.0	294	6	120	111053
⊕ 1 × 75	⊕No.1	75	5.8	27.0	182		6	120	111054
⊕ 2 × 100	⊕No.2	100	6.4	30.5	223		6	120	111055
⊕ 2 × 300	⊕No.2	300	6.4	30.5	423		6	60	111066
⊕ 3 × 150	⊕No.3	150	8.0	34.0	294		6	120	111056

### No. 350 Wooden Handle Tang-Thru Screwdriver

- Widely-used standard wooden handle screwdriver.
- Wooden handle and Tang-Thru shank with large end cap.
- Shot blasting tip.

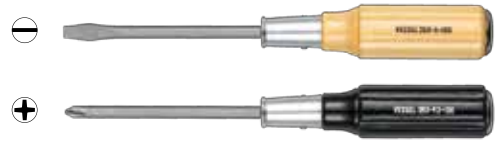

No.350							Inner Ctn.	Outer Ctn.	EDP No.
⊖ 5.5 × 75	5.5	0.8	75	5.5	25	178	12	120	111002
⊖ 6 × 100	6.0	0.9	100	6.3	28	218	12	240	111003
⊖ 8 × 150	8.0	1.1	150	8.0	33	283	6	120	111005
⊖ 9 × 200	9.0	1.2	200	9.0	36	355	6	60	111006
⊖ 10 × 300	10.0	1.2	300	9.0	36	455	6	60	111008
⊕ 1 × 75	⊕No.1	75	5.0	25	178		12	120	111010
⊕ 2 × 100	⊕No.2	100	6.3	28	218		12	240	111011
⊕ 3 × 150	⊕No.3	150	8.0	33	283		6	120	111012
⊕ 4 × 200	⊕No.4	200	9.0	36	355		6	60	111013

## One point

### Furniture-quality grip...

These grips are one size larger than the usual, and have been given a furniture type finish for an especially high-quality feel.

Especially large, heavy-duty end cap.

An especially large end cap efficiently delivers the shock of the hammer blow.

When tapped with a hammer, and adjusting the force of the tapping to the condition of the material concerned, this screwdriver can be used effectively to loosen stripped or rusted screws.



- 1...Thick-wall nut
- 2...Natural wood
- 3...Pin
- 4...Shank



A hammer's impact force is transmitted efficiently.

### No. 350 Wooden Handle Tang-Thru Screwdriver (Long Shank Type)

- Wooden handle and Tang-Thru shank.
- Long shank for fastening in a hard-to-reach space.



No.350							Inner Ctn.	Outer Ctn.	EDP No.
⊖ 6 × 200	6.0	0.9	200	6.3	28	320	12	120	111018
⊖ 6 × 250	6.0	0.9	250	6.3	28	370	12	120	111019
⊖ 6 × 300	6.0	0.9	300	6.3	28	420	12	120	111020
⊕ 2 × 200	⊕No.2	200	6.3	28	320		12	120	111024
⊕ 2 × 250	⊕No.2	250	6.3	28	370		12	120	111025
⊕ 2 × 300	⊕No.2	300	6.3	28	420		12	120	111026

### No. 30 "SPLIT" Handle Screwdriver

- Joined Tang-Thru shank and handle. Super strong type.

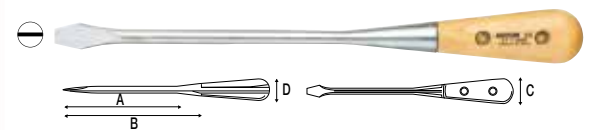

No.30							Inner Ctn.	Outer Ctn.	EDP No.		
⊖ 9.5 × 150	9.5	1.2	9.5	145	190	35	29	285	6	120	113101
⊖ 11 × 200	11	1.2	11	195	255	38	32	360	6	120	113102

No. 300

# Wood-Compo Screwdriver



Maintenance of cars, motorbikes and machines always involves oils. Wood-compo screwdriver's coarse wood powder on the grip surface stops the oil flow against the tightening torque, producing an outstanding non-slip grip effect.

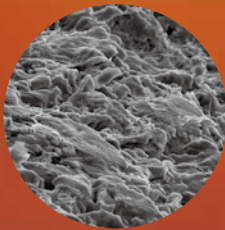

A D V A N C E D

## NON-SLIP

T E C H N O L O G Y

**No. 300**

### Wood-Compo Screwdriver

The grip part is made by unique mold injection technique for "wood resin" which is a compound of wood powder and plastic. Wood powder is the main material, realizing texture and feeling to fit comfortably in your hand like those made of natural wood.

※The above illustration is for reference only.

HAND TOOLS

BITS & SOCKETS

ELECTRIC TOOLS

AIR TOOLS

STATIC SOLUTIONS

GASOLINE ENGINE TOOLS



### No. 300 Wood-Compo Screwdriver PAT.

- Extraordinary non-slip grip; Secure working efficiency even with oily hands. 
- Wood-composite resin, reproducing the natural material texture.
- Rust-resistant black chrome plating shank.



No.300							Inner Ctn. (mm)	Outer Ctn.	EDP No.
⊖ 5.5× 75	5.5	0.8	75	5.5	30	182	6	120	120021
⊖ 6× 100	6.0	0.9	100	6.4	32	215	6	120	120022
⊖ 6× 150	6.0	0.9	150	6.4	32	265	6	120	120027
⊖ 8× 150	8.0	1.1	150	8.0	35	275	6	120	120023
⊕ 1× 75	⊕No.1	75	5.5	30	182		6	120	120024
⊕ 2× 100	⊕No.2	100	6.4	32	215		6	120	120025
⊕ 2× 150	⊕No.2	150	6.4	32	265		6	120	120029
⊕ 3× 150	⊕No.3	150	8.0	35	275		6	120	120026

### No. B-330 Wood-Compo Tang-Thru Screwdriver PAT.

- Extraordinary non-slip grip; Secure working efficiency even with oily hands. 
- Tang-thru type, which can be tapped by a hammer. With star-shaped nut. 
- Rust-resistant black chrome plating shank.



No.B-330							Inner Ctn. (mm)	Outer Ctn.	EDP No.
⊖ 5.5× 75	5.5	0.8	75	5.5	30	183	6	120	120041
⊖ 6× 100	6.0	0.9	100	6.4	32	217	6	120	120042
⊖ 6× 150	6.0	0.9	150	6.4	32	267	6	60	120043
⊖ 8× 150	8.0	1.1	150	8.0	35	277	6	60	120044
⊕ 1× 75	⊕No.1	75	5.5	30	183		6	120	120045
⊕ 2× 100	⊕No.2	100	6.4	32	217		6	120	120046
⊕ 2× 150	⊕No.2	150	6.4	32	267		6	60	120047
⊕ 3× 150	⊕No.3	150	8.0	35	277		6	60	120048

### No. B-300 Wood-Compo S/D (w/hanging card) PAT.

- Extraordinary non-slip grip; Secure working efficiency even with oily hands. 
- Wood-composite resin, reproducing the natural material texture.
- Rust-resistant black chrome plating shank.



No.B-300							Inner Ctn. (mm)	Outer Ctn.	EDP No.
⊖ 5.5× 75	5.5	0.8	75	5.5	30	183	6	120	120071
⊖ 6× 100	6.0	0.9	100	6.4	32	217	6	120	120072
⊖ 6× 150	6.0	0.9	150	6.4	32	267	6	60	120073
⊖ 8× 150	8.0	1.1	150	8.0	35	277	6	60	120074
⊕ 1× 75	⊕No.1	75	5.5	30	183		6	120	120075
⊕ 2× 100	⊕No.2	100	6.4	32	217		6	120	120076
⊕ 2× 150	⊕No.2	150	6.4	32	267		6	60	120077
⊕ 3× 150	⊕No.3	150	8.0	35	277		6	60	120078

### No. 320 Wood-Compo Screwdriver (Stubby Type) PAT.

- Stubby type, which is convenient for tightening screws in cramped spaces. 
- Wood-composite resin, reproducing the natural material texture.
- Rust-resistant black chrome plating shank.



No.320							Inner Ctn. (mm)	Outer Ctn.	EDP No.
⊖ 6× 15	6.0	0.9	15	6.0	35	68	6	120	120035
⊕ 2× 15	⊕No.2	15	6.0	35	68		6	120	120037



Ultimate Non-Slip Screwdriver even with oily hands

Uses biomass plastic which contains 70% wood powder. This compound material forms the wood-compo screwdrivers, which is a new product of a category that can be called a "new wooden handled" screwdriver with texture of wood and excellent strength. At development phase, this product proved to be "non-slip" even in an oily hand. This feature is most applicable to work that involves oil such as car maintenance and iron work.



One point

## No. B-340TX

### Wood-Compo TORX Screwdriver

PAT.

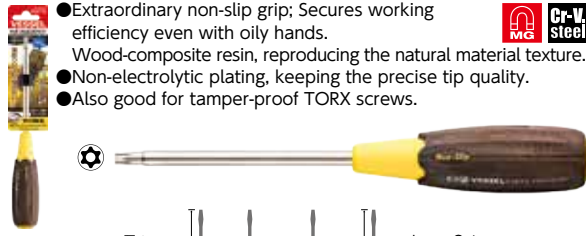

- Extraordinary non-slip grip; Secures working efficiency even with oily hands. Wood-composite resin, reproducing the natural material texture.
- Non-electrolytic plating, keeping the precise tip quality.
- Also good for tamper-proof TORX screws.



No. B-340TX	Inner Ctn.	Outer Ctn.	EDP No.
T10Hx 80	2.72	80 5.5 30 188	6 120 120081
T15Hx 80	3.26	80 5.5 30 188	6 120 120082
T20Hx 120	3.84	120 5.5 30 228	6 120 120083
T25Hx 120	4.40	120 6.4 32 236	6 60 120084
T27Hx 120	4.96	120 6.4 32 236	6 60 120085
T30Hx 120	5.49	120 8.0 35 246	6 60 120086
T40Hx 120	6.60	120 8.0 35 246	6 60 120087

TORX® is a registered trademark of Acument™ Intellectual Properties, LLC (USA). VESSEL has a manufacturing license in Japan and selling same to the world.

## No. B-380NT

### Wood-Compo Socket Screwdriver

PAT.

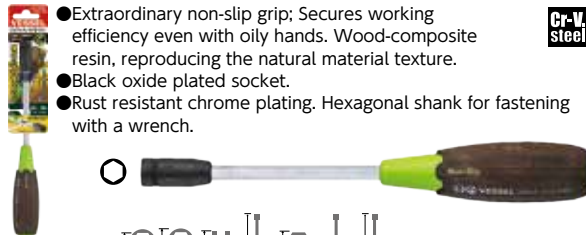

- Extraordinary non-slip grip; Secures working efficiency even with oily hands. Wood-composite resin, reproducing the natural material texture.
- Black oxide plated socket.
- Rust resistant chrome plating. Hexagonal shank for fastening with a wrench.



No. B-380NT	Inner Ctn.	Outer Ctn.	EDP No.
A/F 5 x125	5 8 18 125 5.0 30.0 224	6 60	120091
A/F 5.5x125	5.5 9 18 125 5.0 30.0 224	6 60	120092
A/F 7 x125	7 10 18 125 5.0 30.0 224	6 60	120093
A/F 8 x125	8 12 20 125 5.0 32.0 233	6 60	120094
A/F 10 x125	10 15 20 125 7.0 32.0 233	6 60	120095
A/F 12 x150	12 17 20 125 7.0 32.0 233	6 60	120096
A/F 13 x150	13 19 22 125 7.0 32.0 233	6 60	120097
A/F 14 x150	14 19 22 125 7.0 32.0 233	6 60	120098

## No. B-370 Non-slip Tang-Thru Screwdrivers

- Unique Non-Slip finish that prevents slipping even if oil adheres on the grip.



- Tang-thru type with a large nut. Good for heavy duty work.
- The end of the handle has a color ring facilitates to distinguish the tip difference at a glance.

No. B-370	Inner Ctn.	Outer Ctn.	EDP No.
⊖ 5.5x 75	5.5 0.8 75 5.5 27.4 183	6 60	267590
⊖ 6 x 100	6.0 0.9 100 6.4 30.7 226	6 60	267591
⊖ 8 x 150	8.0 1.1 150 8.0 36.2 290	6 60	267592
⊕ 1 x 75	⊕No.1 75 5.5 27.4 183	6 60	267593
⊕ 2 x 100	⊕No.2 100 6.4 30.7 226	6 60	267594
⊕ 3 x 150	⊕No.3 150 8.0 36.2 290	6 60	267595

## No. HRH

### Wood-Compo Ratchet Handle NEW



- Wedge type 72-tooth gear ratchet realizes a ultra small and highly durable head.
- Non-slip wood-composite handle 1/4sq.(6.35mm), reproducing the natural material texture.

No. HRH	Designation Insertion	Feed Angle	D	H	H2	L (mm)	Inner Ctn.	Outer Ctn.	EDP No.
HRH2-W	1/4"sq.(6.35mm)	5°	20	20	30	145	6	60	162004
HRH3-W	3/8"sq.(9.5mm)	5°	25	27	30	180	6	60	162005

## No. HRH

### Wood-Compo Swivel Ratchet Handle NEW

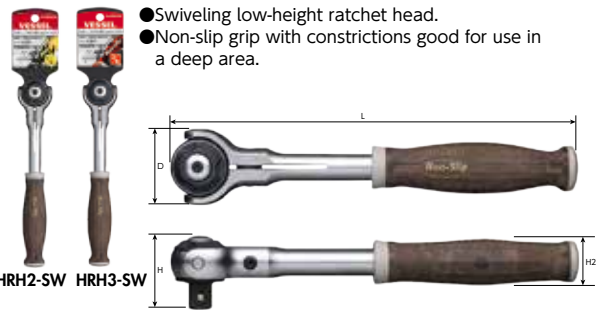

- Swiveling low-height ratchet head.
- Non-slip grip with constrictions good for use in a deep area.

No. HRH	Designation Insertion	Feed Angle	D	H	H2	L (mm)	Inner Ctn.	Outer Ctn.	EDP No.
HRH2-SW	1/4"sq.(6.35mm)	5°	32	26.4	19.5	169	6	60	162104
HRH3-SW	3/8"sq.(9.5mm)	5°	32	29.5	19.5	169	6	60	162105

## No. HRW2001M-W

### Wood-Compo Socket Wrench Set NEW

- Wedge type 72-tooth gear ratchet realizes a ultra small and highly durable head.
- Non-slip wood-composite handle 1/4sq.(6.35mm), reproducing the natural material texture.
- Surface contact sockets, avoiding the damage on the edges of bolts or nuts.



1/4"sq.(6.35mm) 36pcs.

No. HRW2001M-W	Set content	EDP No.
	Wood-Compo ratchet handle 1/4"sq.(6.35mm)	162001
	Wood-Compo stubby handle 1/4"sq.(6.35mm)	
	Universal socket adaptor 1/4"sq.(6.35mm)	
	Extension bar Overall length 100mm 1/4"sq.(6.35mm)	
	Bit socket adaptor 1/4"sq.⇔1/4"hex.	
	1/4"sockets: 4, 4.5, 5, 5.5, 6, 7, 8, 9, 10, 11, 12, 13, 14mm	
	Bits: ⊖4, 6, ⊕1, 2, 3, H1.5, H2, H2.5, H3, H4, H5, T10, T15, T20, T25, T27, T30, T40	

Inner Ctn.: 3 sets, Outer Ctn.: 9 sets

HAND TOOLS

BITS & SOCKETS

ELECTRIC TOOLS

AIR TOOLS

STATIC SOLUTIONS

GASOLINE ENGINE TOOLS

## No. HRW3002M-W

### Wood-Compo Socket Wrench Set **NEW**

- Wedge type 72-tooth gear ratchet realizes a ultra small and highly durable head.
- Non-slip wood-composite handle 3/8sq.(9.5mm), reproducing the natural material texture.
- Surface contact sockets, avoiding the damage on the edges of bolts or nuts.



3/8"sq.(9.5mm) 16pcs.

	Set content	EDP No.
<b>HRW3002M-W</b>	Wood-Compo ratchet handle 3/8"sq.(9.5mm) Universal socket adaptor 3/8"sq.(9.5mm) Sliding T-shaped handle 3/8"sq.(9.5mm) Extension bar Overall length 150mm 3/8"sq.(9.5mm) Extension bar Overall length 75mm 3/8"sq.(9.5mm) 3/8" sockets: A/F7, 8, 10, 11, 12, 13, 14, 17, 19, 21, 22mm	162002

Inner Ctn.: 3 sets, Outer Ctn.: 9 sets

## No. HRW2004M-SW

### Wood-Compo Swivel Socket Wrench Set **NEW**

- The non-slip ratchet handle has the constricted end, which facilitates tightening work in a deep area.
- Low height ratchet swiveling head can be used for quick turning like a screwdriver, by setting the handle vertically to the head.
- Dodecagonal sockets for improved workability.
- Quick spinner to turn quickly sockets, even a small one.

Dodecagonal socket



Quick spinner, turning quickly sockets, even a small one.



1/4"sq.(6.35mm) 21pcs.

	Set content	EDP No.
<b>HRW2004M-SW</b>	Wood-Compo swivel ratchet handle 1/4"sq. (6.35mm) Extension bar Overall length 55mm 1/4"sq. (6.35mm) Extension bar Overall length 150mm 1/4"sq. (6.35mm) Quick spinner 1/4"sq. (6.35mm) Hex key wrench: H2.5, 3, 4, 5, 6, 8mm 1/4"sockets: A/F5, 5.5, 6, 7, 8, 9, 10, 11, 12, 13, 14mm	162102

Inner Ctn.: 3 sets, Outer Ctn.: 9 sets

## No. HRW2303M-W

### Wood-Compo Socket Wrench Set **NEW**

- Wedge type 72-tooth gear ratchet realizes a ultra small and highly durable head.
- Non-slip wood-composite handle 1/4sq.(6.35mm) and 3/8sq.(9.5mm), reproducing the natural material texture.
- Surface contact sockets, avoiding the damage on the edges of bolts or nuts.



1/4"sq.(6.35mm)/3/8"sq.(9.5mm) 36pcs.

	Set content	EDP No.
<b>HRW2303M-W</b>	Wood-Compo ratchet handle 3/8"sq. (9.5mm) Wood-Compo spinner handle 1/4"sq. (6.35mm) Universal socket adaptor 3/8"sq. (9.5mm) Extension bar Overall length 150mm 3/8"sq. (9.5mm) Bit socket adaptor 1/4"sq.⇔1/4"hex. 1/4"sockets: A/F4, 4.5, 5, 5.5, 6, 7, 8mm 3/8"sockets: A/F10, 11, 12, 13, 14, 17, 19, 21, 22mm Bits: ⊖4, 6, ⊕1, 2, 3, H3, H4, H5, H6, T10, T15, T20, T25, T30, T40	162003

Inner Ctn.: 3 sets, Outer Ctn.: 9 sets

## No. HRW3005M-SW

### Wood-Compo Swivel Socket Wrench Set **NEW**

- The non-slip ratchet handle has the constricted end, which facilitates tightening work in a deep area.
- Low height ratchet swiveling head can be used for quick turning like a screwdriver, by setting the handle vertically to the head.
- Dodecagonal sockets for improved workability.
- Deep hole sockets, also dodecagonal, are included.
- Quick spinner to turn quickly sockets, even a small one.

Dodecagonal socket



Deep hole socket



Depth: A/F 8.....15mm  
A/F 10/12/14.....30mm

Quick spinner, turning quickly sockets, even a small one.



3/8"sq.(9.5mm) 16pcs.

	Set content	EDP No.
<b>HRW3005M-SW</b>	Wood-Compo swivel ratchet handle 3/8"sq. (9.5mm) Extension bar Overall length 55mm 3/8"sq. (9.5mm) Quick spinner 3/8"sq. (9.5mm) Deep socket 3/8"sq. (9.5mm): H8, 10, 12, 14mm 3/8"sockets: A/F8, 10, 12, 13, 14, 17, 19, 21, 24mm	162103

Inner Ctn.: 3 sets, Outer Ctn.: 9 sets

No. 990

# G-grip Screwdriver



This precision screwdriver is perfect for the delicate screw tightening operations of precision work. Our high-precision, tip process conforms to JIS and JCIS standards. The ergonomic grips employed enable a smoother torque transfer.



**No. 990**

## G-grip Screwdriver

Quick-turning screwdriver, taking advantage of the gravity force. The perfect shape for high-precision work

The weight of the internal steel ball freely rotates the cap in the palm of the hand to provide the optimum grip position.

※The above illustration is for reference only.

HAND TOOLS

BITS & SOCKETS

ELECTRIC TOOLS

AIR TOOLS

STATIC SOLUTIONS

GASOLINE ENGINE TOOLS

### No.990 G-grip Screwdriver

PAT.

●The weight of the steel ball keeps the end cap in an optimum position for a grip.



- Black point tip, fitting well screws.
- Slotted tip is cut straight.



No.990

									Inner Ctn.	Outer Ctn.	EDP No.
⊖ 1.8× 50	1.8	0.25	50	2.5	16	21	148	12	240	125901	
⊖ 2.5× 75	2.5	0.3	75	2.5	16	21	173	12	240	125902	
⊖ 3 × 100	3	0.5	100	3.0	16	21	198	12	240	125903	
⊖ 4 × 100	4	0.6	100	4.0	16	21	198	12	240	125904	
⊖ 5 × 100	5	0.8	100	5.0	30	38	215	6	60	125905	
⊕ 00 × 75	⊕No.00	75	2.5	16	21	173		12	240	125911	
⊕ 0 × 100	⊕No.0	100	3.0	16	21	198		12	240	125912	
⊕ 1 × 100	⊕No.1	100	3.0	30	38	215		6	60	125913	
⊕ 2 × 100	⊕No.2	100	5.0	30	38	215		6	60	125914	

### No.990TX G-grip TORX Screwdriver

PAT.

●The weight of the steel ball keeps the end cap in an optimum position for a grip.



- A special precision spring is welded to the tip by laser, enabling the screwdriver to catch a TORX screw firmly by spring action.

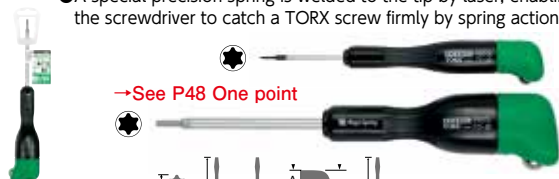

No.990TX

									Inner Ctn.	Outer Ctn.	EDP No.
T3 × 40	1.13	40	2.5	16	21	138	12	240	125921		
T5 × 40	1.42	40	2.5	16	21	138	12	240	125923		
MagicSpring T6 × 40	1.69	40	2.5	16	21	138	12	240	125924		
MagicSpring T8 × 40	2.3	40	2.5	16	21	138	12	240	125926		
MagicSpring T9 × 40	2.48	40	4.0	16	21	138	12	240	125927		
MagicSpring T10×80	2.72	80	4.0	30	38	195	6	60	125928		
MagicSpring T15×80	3.26	80	5.5	30	38	195	6	60	125929		
MagicSpring T20×80	3.84	80	5.5	30	38	195	6	60	125930		

TORX® is a registered trademark of Acument TM Intellectual Properties, LLC (USA). VESSEL has a manufacturing license in Japan and selling same to the world.

### No.9900 Micro Screwdriver

- Equipped with a cap for fast turning on the grip.
- Remarkably highly precise black point tip.



No.9900

									Inner Ctn.	Outer Ctn.	EDP No.
⊖ 1.8× 50	1.8	0.25	50	2.5	10	145	12	120	125621		
⊖ 2.5× 75	2.5	0.35	75	2.5	10	170	12	120	125622		
⊖ 3 × 100	3	0.45	100	3	10	195	12	120	125623		
⊖ 3 × 150	3	0.45	150	3	10	245	12	120	125624		
⊕ 00 × 75	⊕No.00	75	2.5	10	170	12	120	120	125625		
⊕ 0 × 100	⊕No.0	100	3	10	195	12	120	120	125626		
⊕ 0 × 150	⊕No.0	150	3	10	245	12	120	120	125627		

### No.9902/9903 3-Piece Micro Screwdriver Set

- 2 types recommended to precision fields.



- Set of frequently used sizes.
- For adjustment and repair of precision device, electric device, glasses, watches, etc.



Model No.	Set content	Package size (mm)	Inner Ctn.	Outer Ctn.	EDP No.
9902	No.9900 ⊕00×75, ⊕0×100, ⊖1.8×50	235×70×15	5	30	125636
9903	No.9900 ⊕00×75, ⊖2.5×75, ⊖3×100	235×70×15	5	30	125637

## One point

### Features of the precision tip

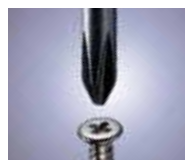

Precisely-finished tip-end good for minuscule screws  
**No.990 / No.9900**

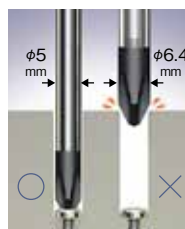

A deep recessed area can also be accessed by the thin shank!

**No.990**



6mm hole, M3 round head screw, and screw head dia. of φ5.5 mm



Two-step flat shape, enabling the tip to fit into a screw

**No.990**



StepFlat

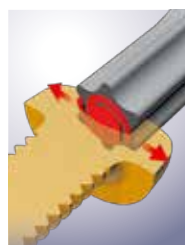

Catches a TORX screw

A special-shape spring is welded to the tip by laser.

**No.990TX**



MagicSpring

TORX® is a registered trademark of Acument TM Intellectual Properties, LLC (USA). VESSEL has a manufacturing license in Japan and selling same to the world.

**No. TD-51 Precision Micro Screwdriver**

- The main body is made of stainless steel (the end cap is made of resin).
- For assembly, repair, and disassembly of precision devices, cameras, watches, glasses, etc.



No. TD-51	Ø	2.2	2.5	3.0	3.5	4.0	4.5	5.0	5.5	Cushion Grip color (mm)	Inner Ctn.	Outer Ctn.	EDP No.
0.7	0.7	0.15	10	0.7	90	Purple	10	100	251350				
0.9	0.9	0.2	10	0.9	90	Green	10	100	251351				
1.2	1.2	0.25	10	1.2	90	Blue	10	100	251352				
1.8	1.8	0.3	20	1.8	100	Black	10	100	251353				
2.3	2.3	0.35	22	2.3	102	Purple	10	100	251354				
3.0	3.0	0.4	26	3.0	106	Red	10	100	251355				
3.5	3.5	0.5	28	3.5	108	Yellow	10	100	251356				
⊕0000	⊕No.0000	17	1.4	97		Lemon	10	100	251394				
⊕000	⊕No.000	20	1.6	100		Yellow-green	10	100	251393				
⊕00	⊕No.00	24	2.4	104		Red	10	100	251357				
⊕0	⊕No.0	26	3.0	106		Yellow	10	100	251358				
⊕1	⊕No.1	26	3.0	106		Green	10	100	251359				

Package size...160×35×14mm

**No. TD-54 Watch Band Pin Punch**

- The main body is made of stainless steel (the end cap is made of resin).
- For adjustment of the watch band.



No. TD-54	Ø	2.2	2.5	3.0	3.5	4.0	4.5	5.0	5.5	Cushion Grip color (mm)	Inner Ctn.	Outer Ctn.	EDP No.
0.7	0.7	10	0.7	90							10	100	251380

Package size...160×35×14mm

**No. TD-54 IPR Precision Pentalobe Screwdriver NEW**

- The main body is made of stainless steel (the end cap is made of resin).
- For assembly, repair, and disassembly of precision devices. Smartphones. Laptops.



No. TD-54	Ø	2.2	2.5	3.0	3.5	4.0	4.5	5.0	5.5	Cushion Grip color (mm)	Inner Ctn.	Outer Ctn.	EDP No.
1IPR	0.84	20	100			Red	10	100	251378				
4IPR	1.29	20	100			Yellow	10	100	251379				

Package size...160×35×14mm

**No. TD-52 Precision Nutdriver**

- The main body is made of stainless steel (the end cap is made of resin).
- For assembly, repair, and disassembly of precision devices, spacer, toys, etc.

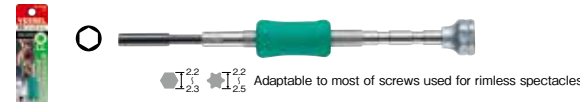

Adaptable to most of screws used for rimless spectacles

No. TD-52	Ø	2.2	2.5	3.0	3.5	4.0	4.5	5.0	5.5	Cushion Grip color (mm)	Inner Ctn.	Outer Ctn.	EDP No.
2.2	—	4.0	12	25	3.0	105	Green	10	100	251361			
A/F 3.0	3.0	5.0	7	25	3.0	105	Blue	10	100	251362			
A/F 4.0	4.0	6.0	9	25	3.0	105	Black	10	100	251363			
A/F 4.5	4.5	6.5	10	25	3.0	105	Purple	10	100	251364			
A/F 5.0	5.0	7.0	11	25	3.0	105	Red	10	100	251365			
A/F 5.5	5.5	8.0	10	25	3.0	105	Yellow	10	100	251366			

Package size...160×35×14mm

**No. TD-59 Precision TORX® Screwdriver NEW**

- The main body is made of stainless steel (the end cap is made of resin).
- For assembly, repair, and disassembly of precision devices. Smartphones. Laptops.



No. TD-59	Ø	2.2	2.5	3.0	3.5	4.0	4.5	5.0	5.5	Cushion Grip color (mm)	Inner Ctn.	Outer Ctn.	EDP No.
T1	0.84	20	100			Green	10	100	251385				
T2	0.94	20	100			Blue	10	100	251386				
T3	1.12	20	100			Black	10	100	251387				
T4	1.3	20	100			Purple	10	100	251388				
T5	1.37	20	100			Yellow	10	100	251390				

Package size...160×35×14mm

**No. TD-53 Precision Hex Driver**

- The main body is made of stainless steel (the end cap is made of resin).
- For assembly, repair, and disassembly of precision devices, toys, etc.



No. TD-53	Ø	2.2	2.5	3.0	3.5	4.0	4.5	5.0	5.5	Cushion Grip color (mm)	Inner Ctn.	Outer Ctn.	EDP No.
H 0.89	0.89	18	98			Green	10	100	251371				
H 1.27	1.27	18	98			Blue	10	100	251372				
H 1.5	1.5	18	98			Black	10	100	251373				
H 2.0	2.0	24	104			Purple	10	100	251374				
H 2.5	2.5	24	104			Yellow	10	100	251375				

Package size...160×35×14mm

**One point**

**Speed tightening**

Both cushion grip and knurled section should be used for quick tightening.

**Precision tightening**

Press the cushion grip firmly and make a rotation.

**Perfect! for such micro screws!!**

World's smallest screw with M0.5 size \* according to Us

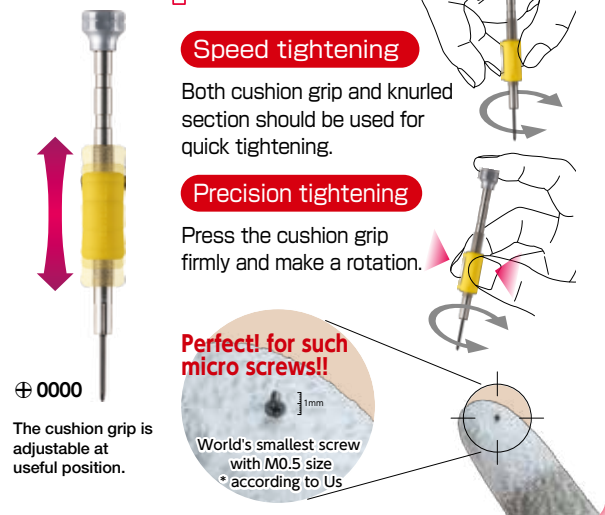

⊕ 0000  
The cushion grip is adjustable at useful position.

HAND TOOLS

BITS & SOCKETS

ELECTRIC TOOLS

AIR TOOLS

STATIC SOLUTIONS

GASOLINE ENGINE TOOLS



### No. TD-54 3ULR Precision Micro Stix® Screwdriver NEW

- The main body is made of stainless steel (the end cap is made of resin).
- For assembly, repair, and disassembly of Smartphones, Laptops, Video Games, HDD.



No. TD-54 3ULR				Cushion (mm)	Grip color	Inner Ctn.	Outer Ctn.	EDP No.
M	0.5	20	100		Lemon	10	100	251425
00	0.7	20	100		Blue	10	100	251424
F	0.9	20	100		Green	10	100	251423
0	1.1	20	100		Blue	10	100	251422
1	1.4	20	100		Black	10	100	251421

Package size---160×35×14mm

### No. TD-58 Precision Hex. Driver Set

- The main body is made of stainless steel (the end cap is made of resin).
- Provided in a portable transparent case.



Model No.	Model Name	Set content	Package size (mm)	Inner Ctn.	EDP No.
TD-58	Precision Hex. driver Set	●0.89, ●1.27, ●1.5, ●2.0, ●2.5, ⊕00	140×86×20	10	251384

### No. TD-55/56/56S/56Y Precision Screwdriver Set

- The main body is made of stainless steel (the end cap is made of resin).
- Provided in a portable transparent case.



Model No.	Model Name	Set content	Package size (mm)	Inner Ctn.	EDP No.
TD-55	Precision Screwdriver Set	⊖0.9, ⊖1.2, ⊖1.8, ⊖2.3, ⊖3.0, ⊖3.5	140×86×20	10	251381
TD-56	Precision Screwdriver Set	⊖0.9, ⊖1.2, ⊖1.8, ⊖2.3, ⊕00, ⊕0	140×86×20	10	251382
TD-56S	Precision Screwdriver Set	⊖0.7, ⊖0.9, ⊕0000, ⊕000, ⊕00, ⊕0	140×86×20	10	251389
TD-56Y	Precision Screwdriver Set	●3ULR-M, F, 0, ●1IPR, ●T5, ⊕00	140×86×20	10	251401

### No. 9000 Ceramic Adjuster

- Uses a zirconia ceramics tip, non-inductive magnetic substance.
- Optimum for coil and trimmer adjustments.
- For the adjustment of electronic parts, such as audio instruments, computers, telecommunication devices, electronics components, and electric components.

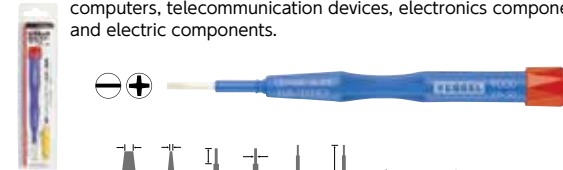

No.9000							End cap color	Inner Ctn.	Outer Ctn.	EDP No.
⊖ 0.9×30	0.9	0.4	30	1.8	10	125	Green	10	60	125641
⊖ 1.3×30	1.3	0.4	30	1.8	10	125	White	10	60	125642
⊖ 1.8×30	1.8	0.4	30	1.8	10	125	Yellow	10	60	125643
⊖ 2.6×30	2.6	0.4	30	2.6	10	125	Red	10	60	125644
⊖ 3.4×15	3.4	0.5	15	3.4	10	115	Black	10	60	125645
⊕ 0 ×30	⊕No.0	30	2.6	10	125		Navy blue	10	60	125646
⊕ 1.7×30	⊕Width1.7	30	2.6	10	125		Lilac	10	60	125647

Package size---190×45×14mm

### No. TD-57 Precision Nut Driver Set

- The main body is made of stainless steel (the end cap is made of resin).
- Provided in a portable transparent case.



Model No.	Model Name	Set content	Package size (mm)	Inner Ctn.	EDP No.
TD-57	Precision Nut driver Set	2.2, O3.0, O4.0, O4.5, O5.0, O5.5	140×86×20	10	251383

### No. CA Replacement Ceramic Blade / Ceramic Blade Adapter

- Blade for automatic adjuster.
- Made of zirconia ceramics, offering high durability.
- For the adjustment of electronic parts, such as audio instruments, computers, telecommunication devices and electronic components.

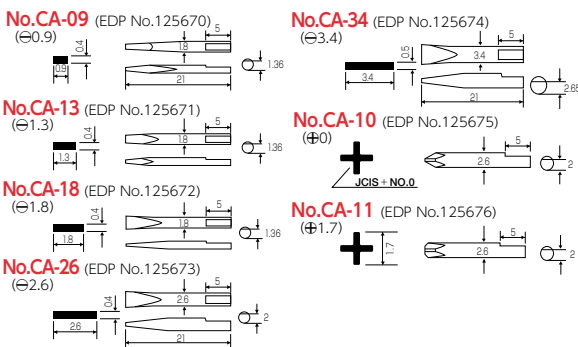

Inner Ctn.:10pcs

# No. TD-6800 Series Ratchet Screwdriver



This functionally enhanced screwdriver enables screw tightening by simple repeated wrist movements.

Improved gear strength combined with our unique ratchet design makes these screwdrivers suitable for the most strenuous tightening jobs.

HAND TOOLS

BITS & SOCKETS

ELECTRIC TOOLS

AIR TOOLS

STATIC SOLUTIONS

GASOLINE ENGINE TOOLS



## No. TD-6804MG Ratchet Screwdriver

Newly developed 72 gear ratchet realizes smooth rotation. You can work by one hand, without grasping over again.

### Ratchet series optimal for a confined area

	Flexible	Plate Ratchet	Screw catcher	Stubby	Driver	Power
At a corner edge						
In a narrow recessed area						
In a deep recessed area						
For force-requiring tightening						
	TD-6700FX-4				TD-6700W-23	S-13
	TD-6700FX-4	TD-74/75/76/77/78/79 TD-70/71/72	TD-73MC TX-12MC	TD-6700W-23		
	TD-6700FX-4				TD-6800 Series	S-12/13
		TD-74/75/76/77/78/79		TD-6700W-23	TD-6800 Series	TD-80 S-12/13 TD-81R/81G/81B

**No. TD-6804MG Ratchet Screwdriver (4-pc bit set)**

- Smoothly click feeling realized by rotating angle of 5° and 72 gears. High strength accomplished by 2 nails supporting the ratchet gear. It can be used for final tightening work.
- The handle is made out of oil-resistance cellulose acetate resin.
- Easy to carry around with cassette type bit storage inside the handle.
- Magnetic bits can be replaced with one-touch.
- Bit insertion part ●6.35mm.



Set content			
Body	length 177mm dia. 28.5mm		
Bits	Φ1, Φ2, Φ3, Φ6 ×25.4mm		
Package size (mm)	Inner Ctn.	Outer Ctn.	EDP No.
235×80×29	5	30	247022

**No. TD-6816MG Ratchet Screwdriver (16-pc bit set)**

- Smoothly click feeling realized by rotating angle of 5° and 72 gears. High strength accomplished by 2 nails supporting the ratchet gear. It can be used for final tightening work.
- The handle is made out of oil-resistance cellulose acetate resin.
- Easy to carry around with cassette type bit storage inside the handle.
- 16 types of bits to adapt to various types of work. Magnetic bits can be replaced with one-touch.
- Bit insertion part ●6.35mm.



Set content			
Body	length 177mm dia. 28.5mm		
Bits	Φ1, Φ2, Φ3, Φ6, H2, H2.5, H3, H4, H5, T10H, T15H, T20H, T25H, T27H, T30H, T40H ×25.4mm		
Package size (mm)	Inner Ctn.	Outer Ctn.	EDP No.
235×90×29	5	30	247025

TORX® is a registered trademark of Acument TM Intellectual Properties, LLC (USA). VESSEL has a manufacturing license in Japan and selling same to the world.

**No. TD-6808MG Ratchet Screwdriver (8-pc bit set)**

- Smoothly click feeling realized by rotating angle of 5° and 72 gears. High strength accomplished by 2 nails supporting the ratchet gear. It can be used for final tightening work.
- The handle is made out of oil-resistance cellulose acetate resin.
- Easy to carry around with cassette type bit storage inside the handle.
- Stores 8 types of bits including HEX bit. Magnetic bits can be replaced with one-touch.
- Bit insertion part ●6.35mm.



Set content			
Body	length 177mm dia. 28.5mm		
Bits	Φ1, Φ2, Φ3, Φ6, H2.5, H3, H4, H5 ×25.4mm		
Package size (mm)	Inner Ctn.	Outer Ctn.	EDP No.
235×80×29	5	30	247023

**No. TD-6700W-23 Ratchet Stubby Screwdriver**

- Improves workability in cramped spaces! Stubby type that fits in your hand.
- Smoothly click feeling realized by rotating angle of 5° and 72 gears. High strength accomplished by 2 nails supporting the ratchet gear. It can be used for final tightening work.
- The handle is made out of oil-resistance cellulose acetate resin.
  - Ball-lock bits can be replaced with one-touch.
  - Bit insertion part ●6.35mm.



Set content			
Body	length 77mm dia. 35mm		
Bits	Φ2 / Φ3 × 35mm		
Package size (mm)	Inner Ctn.	Outer Ctn.	EDP No.
135×70×40	10	60	247026

**No. TD-6808TX Ratchet Screwdriver TORX (8-pc bit set)**

- Smoothly click feeling realized by rotating angle of 5° and 72 gears. High strength accomplished by 2 nails supporting the ratchet gear. It can be used for final tightening work.
- The handle is made out of oil-resistance cellulose acetate resin.
- Easy to carry around with cassette type bit storage inside the handle.
- Stores 8 types of bits including TORX bit. Magnetic bits can be replaced with one-touch.
- Bit insertion part ●6.35mm.



Set content			
Body	length 177mm dia. 28.5mm		
Bits	Φ2, Φ3, T10H, T15H, T20H, T25H, T30H, T40H ×25.4mm		
Package size (mm)	Inner Ctn.	Outer Ctn.	EDP No.
235×80×29	5	30	247024

**No. TD-6700FX-4 Ratchet Stubby Screwdriver with Flexible Shaft**

- Improves workability in cramped spaces! Stubby type that fits in your hand.
- Smoothly click feeling realized by rotating angle of 5° and 72 gears. High strength accomplished by 2 nails supporting the ratchet gear. It can be used for final tightening work.
  - The handle is made out of oil-resistance cellulose acetate resin.
  - Ball-lock bits can be replaced with one-touch.
  - Bit insertion part ●6.35mm.



Set content			
Body	length 77mm dia. 35mm		
Bits	Φ1, Φ2, Φ4, Φ6 × 33mm		
Package size (mm)	Inner Ctn.	Outer Ctn.	EDP No.
235×80×40	5	30	247027

Flexible Shaft (length 165mm)

TORX® is a registered trademark of Acument TM Intellectual Properties, LLC (USA). VESSEL has a manufacturing license in Japan and selling same to the world.

**No. TD-81 Power Ratchet Screwdriver**

- Ratchet fine feed enables to fasten with a little wrist movement.
- Ideal ratchet mechanism for sufficient final tightening.
- 2 double-ended bits (different size combination) can be stored within the handle.
- Bit insertion part ●6.35mm

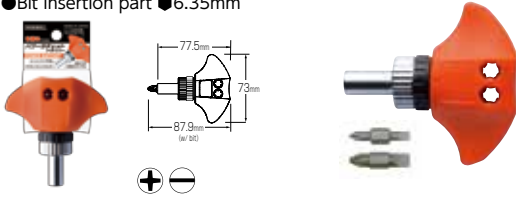

Model No.	Color	Bits	Package size (mm)	Inner Ctn.	EDP No.
TD-81R	Red	⊕1/⊖4, ⊕2/⊖6×25.4	115×73×34	10	250081

**No. TD-80 T-Bar Ratchet Screwdriver**

- Ratchet driving mechanism allows you to tighten a screw without adjusting your grip.
- Bit insertion part ●6.35mm



Set content	
Body	T-bar ratchet screwdriver length 78mm dia. 73mm
Bits	⊕1, ⊕2, ⊕3, ⊖4, ⊖6×25.4mm
Accessory	Bit belt holder

Package size (mm)	Outer Ctn.	EDP No.
170×105×28	40	250080



**No. 2200 Ball Ratchet Screwdriver**

- With 36-teeth gear ratchet to realize comfortable operation with fine tuning.
- Shank cover prevents short circuits. Thin shank is convenient for operating on terminal blocks.



- Shank uses bit materials, fully hardened. Replacement shank is available as option.



**No.2200**

	⊖	⊕	⊖	⊕	⊖	⊕	Inner Ctn. (mm)	Outer Ctn.	EDP No.
⊖6× 100	6.0	0.8	100	6.0	41	200	6	60	125395
⊖6× 150	6.0	0.8	150	6.0	41	250	6	60	125396
⊕2× 100	⊕No.2	100	6.0	41	200	6	60	125345	
⊕2× 150	⊕No.2	150	6.0	41	250	6	60	125346	
⊕3× 150	⊕No.3	150	6.0	41	250	6	60	125347	

⚠ Electric insulation is not guaranteed. For safety purposes, shut off power before use.

**No. 2200B Ball Ratchet Screwdriver Replacement Blade**

- Shank uses bit materials, fully hardened.
- Replacement blade; can be replaced by pulling out the ball-grip part of No.2200.

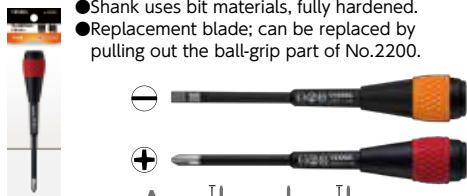

**No.2200B**

	⊖	⊕	⊖	⊕	⊖	⊕	Inner Ctn. (mm)	Outer Ctn.	EDP No.
⊖6× 100	6.0	0.8	100	6.0	158	200	6	60	125397
⊖6× 150	6.0	0.8	150	6.0	208	250	6	60	125398
⊕2× 100	⊕No.2	100	6.0	158	200	6	60	125348	
⊕2× 150	⊕No.2	150	6.0	208	250	6	60	125349	
⊕3× 150	⊕No.3	150	6.0	208	250	6	60	125350	

**One point**

Shanks are detachable from the ratchet part

Replacement blade can be replaced with one-touch.



Ratchet part is also non-conductive

If the ratchet is set in fixed mode, it can be used as screwdriver for electric works with shank cover.

It is most suitable for working on distribution boards.

HAND TOOLS  
BITS & SOCKETS  
ELECTRIC TOOLS  
AIR TOOLS  
STATIC SOLUTIONS  
GASOLINE ENGINE TOOLS

**No. TD-74 Flat-shaped Ratchet Screwdriver (straight type)**

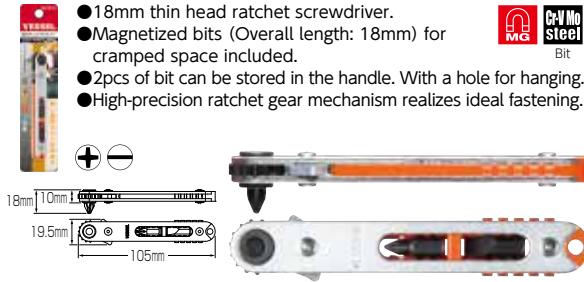

- 18mm thin head ratchet screwdriver.
- Magnetized bits (Overall length: 18mm) for cramped space included.
- 2pcs of bit can be stored in the handle. With a hole for hanging.
- High-precision ratchet gear mechanism realizes ideal fastening.



Model No.	Set content	Package size (mm)	Inner Ctn.	EDP No.
<b>TD-74</b>	Flat-shaped Ratchet Screwdriver (Straight type) Bits $\Phi 1, \Phi 2, \ominus 6 \times 18\text{mm}$	160×35×21	10	250074

**No. TD-77 Flat-shaped Ratchet Screwdriver (bent-up type)**

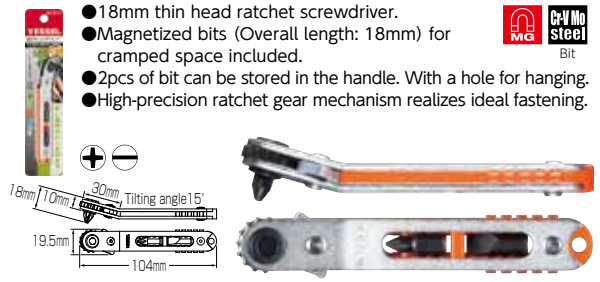

- 18mm thin head ratchet screwdriver.
- Magnetized bits (Overall length: 18mm) for cramped space included.
- 2pcs of bit can be stored in the handle. With a hole for hanging.
- High-precision ratchet gear mechanism realizes ideal fastening.



Model No.	Set content	Package size (mm)	Inner Ctn.	EDP No.
<b>TD-77</b>	Flat-shaped Ratchet Screwdriver (Angled type) Bits $\Phi 1, \Phi 2, \ominus 6 \times 18\text{mm}$	160×35×21	10	250077

**No. TD-75 Flat-shaped Ratchet Screwdriver (straight type)**



- 18mm thin head ratchet screwdriver.
- Magnetized bits (Overall length: 18mm) for cramped space included.
- 2pcs of bit can be stored in the handle. With a hole for hanging.
- High-precision ratchet gear mechanism realizes ideal fastening.



Model No.	Set content	Package size (mm)	Inner Ctn.	EDP No.
<b>TD-75</b>	Flat-shaped Ratchet Screwdriver (Straight type) Bits $\Phi 1, \Phi 2, \Phi 3, \ominus 4, \ominus 6 \times 18\text{mm}$ Bit holder	160×50×21	10	250075

**No. TD-78 Flat-shaped Ratchet Screwdriver (bent-up type)**



- 18mm thin head ratchet screwdriver.
- Magnetized bits (Overall length: 18mm) for cramped space included.
- 2pcs of bit can be stored in the handle. With a hole for hanging.
- High-precision ratchet gear mechanism realizes ideal fastening.



Model No.	Set content	Package size (mm)	Inner Ctn.	EDP No.
<b>TD-78</b>	Flat-shaped Ratchet Screwdriver (Angled type) Bits $\Phi 1, \Phi 2, \Phi 3, \ominus 4, \ominus 6 \times 18\text{mm}$ Bit holder	160×50×21	10	250078

**No. TD-76 Flat-shaped Ratchet Screwdriver (straight type)**



- 18mm thin head ratchet screwdriver.
- Magnetized bits (Overall length: 18mm) for cramped space included.
- 2pcs of bit can be stored in the handle. With a hole for hanging.
- High-precision ratchet gear mechanism realizes ideal fastening.



Model No.	Set content	Package size (mm)	Inner Ctn.	EDP No.
<b>TD-76</b>	Flat-shaped Ratchet Screwdriver (Straight type) Bits $\Phi 1, \Phi 2, \Phi 3, \ominus 4, \ominus 6, \ominus 2.5, \ominus 3, \ominus 4, \ominus 5, \ominus 6 \times 18\text{mm}$ Bit holder	160×50×21	10	250076

**No. TD-79 Flat-shaped Ratchet Screwdriver (bent-up type)**



- 18mm thin head ratchet screwdriver.
- Magnetized bits (Overall length: 18mm) for cramped space included.
- 2pcs of bit can be stored in the handle. With a hole for hanging.
- High-precision ratchet gear mechanism realizes ideal fastening.



Model No.	Set content	Package size (mm)	Inner Ctn.	EDP No.
<b>TD-79</b>	Flat-shaped Ratchet Screwdriver (Angled type) Bits $\Phi 1, \Phi 2, \Phi 3, \ominus 4, \ominus 6, \ominus 2.5, \ominus 3, \ominus 4, \ominus 5, \ominus 6 \times 18\text{mm}$ Bit holder	160×50×21	10	250079

**No. TD-B5 18mm replacement bits**

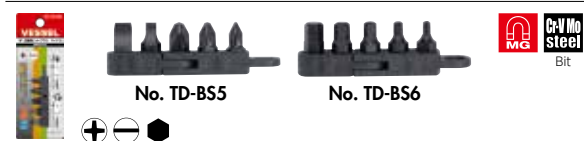

- 18mm thin head ratchet screwdriver.
- Magnetized bits (Overall length: 18mm) for cramped space included.
- 2pcs of bit can be stored in the handle. With a hole for hanging.
- High-precision ratchet gear mechanism realizes ideal fastening.



Model No.	Set content	Package size (mm)	Inner Ctn.	EDP No.
<b>TD-B55</b>	Bits $\Phi 1, \Phi 2, \Phi 3, \ominus 4, \ominus 6 \times 18\text{mm}$ Bit holder	120×40×23	10	251304
<b>TD-B56</b>	Bits $\ominus 2.5, \ominus 3, \ominus 4, \ominus 5, \ominus 6 \times 18\text{mm}$ Bit holder	120×40×23	10	251305

**No. TD-70 Flat Plate Ratchet Screwdriver Set**

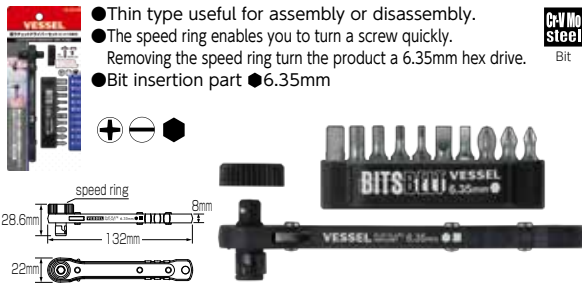

- Thin type useful for assembly or disassembly.
- The speed ring enables you to turn a screw quickly.
- Removing the speed ring turn the product a 6.35mm hex drive.
- Bit insertion part ●6.35mm

CrV Mo Steel Bit

Set content		Package size (mm)	Inner Ctn.	EDP No.
Body	Plate ratchet screwdriver			
Bits	Φ1, Φ2, Φ3, Φ4, Φ6, H2.5, H3, H4, H5, H6×25.4mm			
Accessory	Bit belt holder			

**No. TD-73MC Plate Ratchet Screw Catcher**

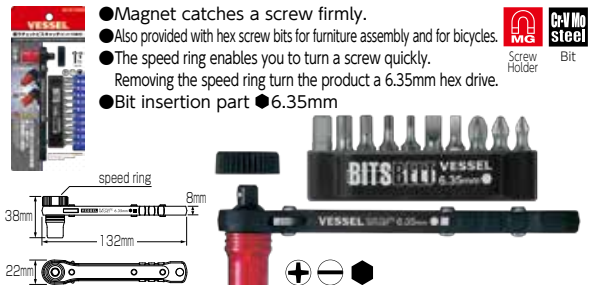

- Magnet catches a screw firmly.
- Also provided with hex screw bits for furniture assembly and for bicycles.
- The speed ring enables you to turn a screw quickly.
- Removing the speed ring turn the product a 6.35mm hex drive.
- Bit insertion part ●6.35mm

MG CrV Mo Steel Screw Holder Bit

Set content		Package size (mm)	Inner Ctn.	EDP No.
Body	Plate ratchet screwdriver			
Bits	Φ1, Φ2, Φ3, Φ4, Φ6, H 2.5, 3, 4, 5, 6×25.4mm			
Accessory	Magnetic Screw Holder Bit belt holder			

**No. TD-71 Flat Plate Ratchet Screwdriver**

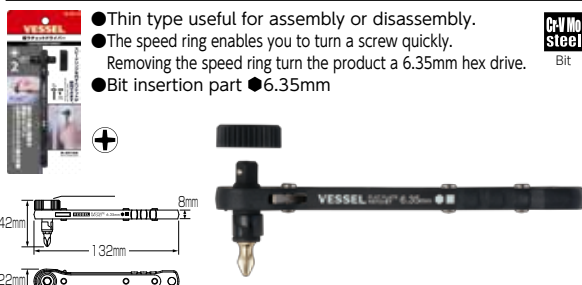

- Thin type useful for assembly or disassembly.
- The speed ring enables you to turn a screw quickly.
- Removing the speed ring turn the product a 6.35mm hex drive.
- Bit insertion part ●6.35mm

CrV Mo Steel Bit

Set content		Package size (mm)	Inner Ctn.	EDP No.
Body	Plate ratchet screwdriver			
Bit	Φ2×25.4mm			

**No. TX-12MC Plate Ratchet/Magnetic Screw Catcher (TORX)**



- Magnet catches a screw firmly.
- Also provided with Torx bits popular in the maintenance. Also used for tamper-proof torx screws.
- The speed ring enables you to turn a screw quickly.
- Removing the speed ring turn the product a 6.35mm hex drive.
- Bit insertion part ●6.35mm

MG CrV Mo Steel Screw Holder Bit

Set content		Package size (mm)	Inner Ctn.	EDP No.
Body	Plate ratchet screwdriver			
Bits	T8H, T10H, T15H, T20H, T25H, T27H, T30H, T40H, Φ2, Φ6×25.4mm			
Accessory	Magnetic Screw Holder Bit belt holder			

**No. TD-72 Flat Plate Ratchet Screwdriver Set**

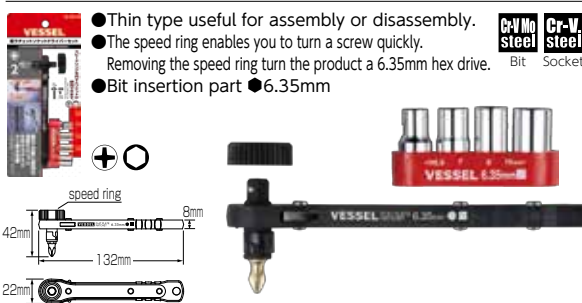

- Thin type useful for assembly or disassembly.
- The speed ring enables you to turn a screw quickly.
- Removing the speed ring turn the product a 6.35mm hex drive.
- Bit insertion part ●6.35mm

CrV Mo Steel Cr-V steel Bit Socket

Set content		Package size (mm)	Inner Ctn.	EDP No.
Body	Plate ratchet screwdriver			
Bit	Φ2×25.4mm			
Sockets	A/F 5.5, 7, 8, 10×26mm			
Accessory	Socket holder			

**No. TX-11 Plate Ratchet TORX Set**



- Storage holder included. For working with tamper-proof screws.
- The speed ring enables you to turn a screw quickly.
- Thin ratchet handle for working in cramped places. Ball locking system.
- Can be used with 6.35 mm across flats short bits and 6.35 mm square hole sockets.

CrV Mo Steel Bit

Set content		Package size (mm)	Inner Ctn.	EDP No.
Body	Plate ratchet screwdriver			
Bits	T8H, T10H, T15H, T20H, T25H, T27H, T30H, T40H, Φ2, Φ6×25.4mm			
Accessory	Magnetic Screw Holder Bit belt holder			

TORX® is a registered trademark of Acument TM Intellectual Properties, LLC (USA). VESSEL has a manufacturing license in Japan and selling same to the world.

HAND TOOLS

BITS & SOCKETS

ELECTRIC TOOLS

AIR TOOLS

STATIC SOLUTIONS

GASOLINE ENGINE TOOLS

### No. TD-BS Replacement Bit Set

**No. TD-BS1** **No. TD-BS2** **No. TD-BS3** **No. TD-BS4**

Applicable models  
 TD-70/TD-71/TD-72/TD-73MC/TD-80/TD-150/TD-160/S-12/S-13  
 TX-10/TX-11/TX-12MC/830MG-4/840/840L

Applicable models  
 TD-70/TD-71/TD-72  
 TD-170  
 TX-11/TD-73MC  
 TX-12MC

Cr-V Steel Bit  
 Cr-V Steel Socket

Model No.	Set content	Package size (mm)	Inner Ctn.	EDP No.
TD-BS1	Φ1, Φ2, Φ3, Φ4, Φ6 ×25.4mm Bit belt holder	120×45×23	10	251300
TD-BS2	H 2.5, 3, 4, 5, 6 ×25.4mm Bit belt holder	120×45×23	10	251301
TD-BS3	T10H, T15H, T20H, T25H, T30H ×25.4mm Bit belt holder	120×45×23	10	251302
TD-BS4	A/F 5.5, 7, 8, 10 Socket holder	120×45×23	10	251303

TORX® is a registered trademark of Acument TM Intellectual Properties, LLC (USA). VESSEL has a manufacturing license in Japan and selling same to the world.

### No. TD-64 "PETADORA" Z-shaped Offset Screwdriver

- S-shaped type good for strong tightening in cramped spaces.
- Special plating to keep precision at the tip.

Cr-V Steel

**No. TD-64**

	Φ2/Φ6	Φ1/Φ2	ΦNo.1	ΦNo.2	18	6	129	10	100	250122
Inner Ctn.	6	0.9	18	6	129	10	100	250122		
Outer Ctn.	6	0.9	18	6	129	10	100	250122		
EDP No.	250122	250121	250122	250121	250122	250121	250122	250121	250122	250121

Package size...160×35×12mm

### No. 25 Offset Screwdriver

- S-shaped type good for strong tightening in cramped spaces.
- Different size tips combined.
- Can be chosen according to applications.

Cr-V Steel

**No. 25**

	Φ1/Φ5	Φ2/Φ6	Φ3/Φ8	25	5	125	12	143005
Inner Ctn.	25	5	125	12	143005			
Outer Ctn.	25	5	125	12	143005			
EDP No.	143005	143006	143007	143005	143006	143007	143005	143006

Package size...160×35×12mm

### No. 251526 2-Piece Offset Screwdriver Set

Model No.	Set content	Package size (mm)	Inner Ctn.	EDP No.
251526	No.25 Φ6/Φ2, Φ5/Φ1	210×70×10	20	243011

### No. TD-61 "PETADORA" L-shaped Offset Screwdriver

- Special plating to keep precision at the tip.
- L-shaped type good for working in cramped spaces.

Cr-V Steel

**No. TD-61**

	Φ6	Φ1	Φ2	6	0.9	18	6	117	Blue	10 <th>100 <th>250105</th> </th>	100 <th>250105</th>	250105
Inner Ctn.	6	0.9	18	6	117	10	100	250105				
Outer Ctn.	6	0.9	18	6	117	10	100	250105				
EDP No.	250105	250101	250102	250105	250101	250102	250105	250101	250102	250105	250101	250102

Package size...160×35×14mm

### No. TD-63 "PETADORA" L-shaped Offset Screwdriver

- Special plating to keep precision at the tip.
- L-shaped type good for working in cramped spaces.

Cr-V Steel

**No. TD-63**

	H 2.5	H 3	H 4	H 5	2.5	16.5	5	105	Orange	10 <th>100 <th>250112</th> </th>	100 <th>250112</th>	250112
Inner Ctn.	2.5	3	4	5	105	10	100	250112				
Outer Ctn.	2.5	3	4	5	105	10	100	250112				
EDP No.	250112	250113	250114	250115	250112	250113	250114	250115	250112	250113	250114	250115

Package size...160×35×14mm

# One point

Speedy fast-turning, firm tightening

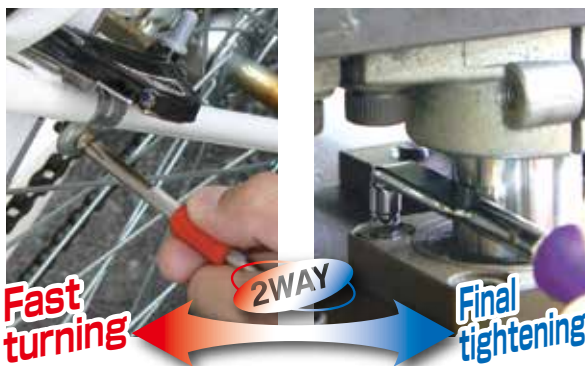

*This one product can be used from fast-turning to tightening!*

An evolution of offset screwdriver with all the required functions for tightening screws.

**No. 83L LED Voltage Detection Screwdriver**

- For conduction/ continuity test in general household.
- Long-life LED lights brightly. Batteries can be replaced.
- Handy pencil-type screwdriver.



Voltage detection range	4.0	0.45	20	17.5	130	Package size (mm)	Inner Ctn.	EDP No.
100 to 250V AC						185×70×16	10	125106

**One point**

**Conductivity check of electrical wiring tools**

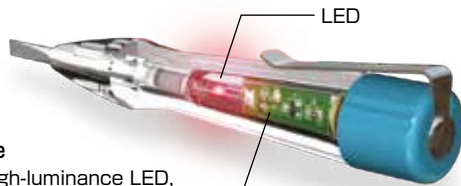

**LED type**

Uses a high-luminance LED, allowing you to check electrical conductivity easily even in a bright location  
Batteries are consumables and need to be replaced.

**Conductivity check / polarity discrimination Continuity test**



A conductivity check of electrical wiring or receptacle and polarity discrimination of AC hot-line and ground sides



Continuity check of a wiring circuit  
Make sure that no power is applied to the circuit before checking continuity.

**No. TD-1300L**

**6-Piece Voltage Detection Screwdriver Set**

- Neon tube integrated into the grip end. When contacting the current-carrying point, the neon tube lights and continuity test can be conducted. **Cr-V steel**
- Resin chuck enables to replace the blades. Lightweight resin grip, with a transparent end-cap at the grip edge.
- Frequently used 6 types of blade in a pack.
- Provided in a handy transparent vinyl carrying and storage pouch.
- Low voltage type (100 to 250V AC)



**No. TD-1300L**

Voltage detection range	Reversible blade content (mm)			Pin extractor	Inner Ctn.	EDP No.
	⊖	⊕	Awl			
100 to 250V AC	⊖4×125	⊕1×125	125	125	10	247021
	⊖6×125	⊕2×125				
Handle length 126.4mm dia. 26.5mm						

\*Package size--185×105×31mm

**No. TD-1300B**

**5-Piece Voltage Detection Screwdriver Set**

- Neon tube integrated into the grip end. When contacting the current-carrying point, the neon tube lights and continuity test can be conducted. **Cr-V steel**  
Except Socket
- Resin chuck enables to replace the blades. Lightweight resin grip, with a transparent end-cap at the grip edge.
- A small diameter type socket suitable for small screws included in replacement blade set.
- Handy vinyl carrying and storage pouch
- Low voltage type (100 to 250V AC)



**No. TD-1300B**

Voltage detection range	Reversible blade content (mm)			Inner Ctn.	EDP No.
	⊖	⊕	Socket		
100 to 250V AC	⊖4×125	⊕1×125	A/F5 ×125	10	247031
		⊕2×125	A/F5.5×125		
Handle length 126.4mm dia. 26.5mm					

\*Package size--185×105×31mm

HAND TOOLS

BITS & SOCKETS

ELECTRIC TOOLS

AIR TOOLS

STATIC SOLUTIONS

GASOLINE ENGINE TOOLS



## No. 240001 Impact Driver

- One-touch switching of the rotation direction.
- Soft non-slip resin handle, comfortable to grip. Designed for less shock on hands.
- For heavy-duty use.
- If the bit adapter is detached, a 12.7 mm socket can be attached.
- Bit insertion part ●8mm



Set content		Package size (mm)	Outer Ctn.	EDP No.
Bits	Φ2×36, Φ2×80, Φ3×36, Φ3×80, Φ4×36, Φ10×36			
Body	length 176mm dia. 37.5mm	220×73×80	5	246051

## No. 250001 Impact Driver

- Effective for very tight fastening and loosening rusted screws.
- Suited for automobile maintenance, and assembly and disassembly of machinery and equipment.
- For heavy-duty use.
- If the bit adapter is detached, a 12.7 mm socket can be attached.
- Bit insertion part ●8mm

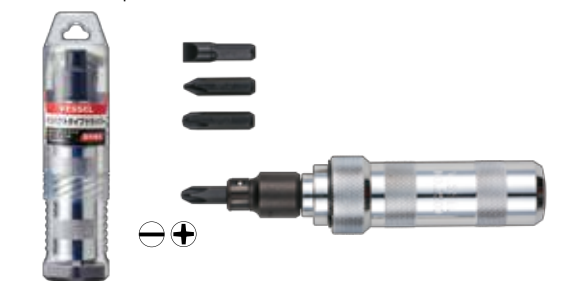

Set content		Package size (mm)	Outer Ctn.	EDP No.
Bits	Φ10, Φ2, Φ3, Φ4×36			
Body	length 166mm dia. 32mm	325×80×38	5	246001

## No. 260002 Impact Uni Driver

- Thin handle. Can be used as normal screwdriver.
- Long shank bit. Ideal for hard-to-reach cramped spaces.
- Bit insertion part ●6.35mm



Set content		Package size (mm)	Outer Ctn.	EDP No.
Bits	Φ5, Φ6, Φ7, Φ1, Φ2, Φ3×125			
Body	length 132.5mm dia. 26mm	225×110×33	5	246016

## No. C50 Impact Driver Bit



Model No.	Set content	Applicable models	Package size (mm)	Inner Ctn.	EDP No.
C502125	Φ2×125	260002	170×42	10	486212
C503125	Φ3×125	260002	170×42	10	486213
C506125	Φ6×125	260002	170×42	10	486216

»For 10-Piece Set, please refer to page 83.

Mounting quantity: 1

## No. C51 Impact Driver Bit



Model No.	Set content	Applicable models	Package size (mm)	Inner Ctn.	EDP No.
C512036	Φ2×36	250001, 240001	170×42	10	486201
C513036	Φ3×36	250001, 240001	170×42	10	486202
C518036	Φ8×36	250001, 240001	170×42	10	486203

»For 10-Piece Set, please refer to page 83.

Mounting quantity: 1

# One point

## Removal of a rusted or stuck screw

Hitting the handle with a hammer causes the impact to be converted into rotational force.



The tip turns counterclockwise at the instant when the handle is hit with a hammer.

Loosened by impact acceleration

No. 8209BP

# "BALL POINT" L-wrenches

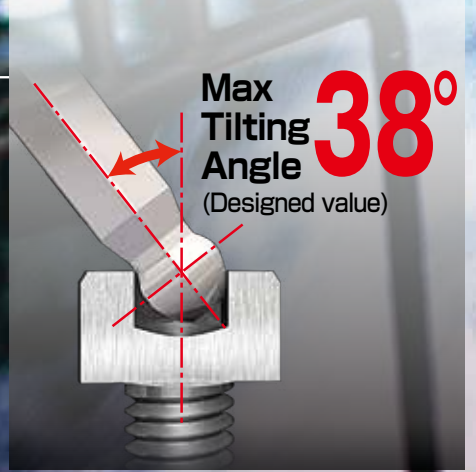

Inclining the wrench moves the driving points toward the entry of the hexagon screw head recess. Even if the neck place of the ball point is thick, the wrench can be inclined up to 38°, the maximum tilting angle.

Magnetized tip can retain a hexagon screw head bolt.

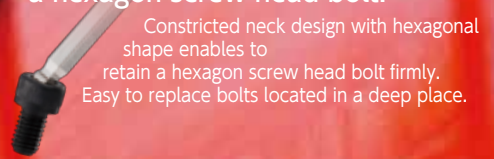

## Resistant to twist and breaking Extra Superalloy

Made in Japan (except 8300HX-S)

With our new L-Wrench technology and design you will be able to perform the final tightening of your work even with the ball point shape.

## One point TORX Wrench Series

Quick tightening at tilted angle.

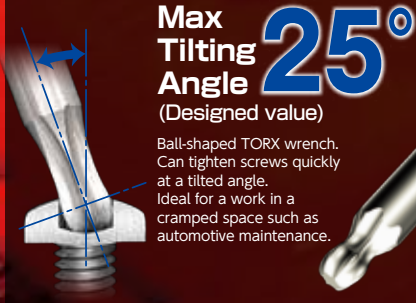

Max Tilting Angle **25°**  
(Designed value)

Ball-shaped TORX wrench. Can tighten screws quickly at a tilted angle. Ideal for a work in a cramped space such as automotive maintenance.

Can be used with tamper-proof screws.



**TORX**® Tip-end processing based on TORX standards. Corresponds to various screws.

No. 8209BP

"BALL POINT" Wrench Stubby 9-PC Set

L-shape angle 95° for easy handling. The arm length is half of the standard arm size.

HAND TOOLS

BITS & SOCKETS

ELECTRIC TOOLS

AIR TOOLS

STATIC SOLUTIONS

GASOLINE ENGINE TOOLS

### No. 8200BP-S Ball Point Wrench Stubby (Short Type) **NEW**

- New ball shape with the maximum tilted angle of 38° (design value in our company).
  - Stubby ideal for cramped spaces
  - L-shape angle 95° for easy handling.
- The arm length is half of the standard arm size.



No.8200BP-S

Size (mm)	Ball Dia (mm)	Ball Dia (mm)	Package Size (mm)	Inner Ctn.	EDP No.
1.5	4	52	160×45×5	10	143887
2	5	58	160×45×5	10	143888
2.5	6	60	160×45×5	10	143889
3	8	65	160×45×5	10	143890
4	9	72	200×60×8	10	143891
5	11	80	200×60×8	10	143892
6	13	90	200×60×8	10	143893
8	16	100	235×75×14	5	143894
10	19	112	235×75×14	5	143895

### No. 8200BP Ball Point Wrench Stubby **NEW**

- New ball shape with the maximum tilted angle of 38° (design value in our company).
  - Stubby ideal for cramped spaces
  - L-shape angle 95° for easy handling.
- The arm length is half of the standard arm size.



No.8200BP

Size (mm)	Ball Dia (mm)	Ball Dia (mm)	Package Size (mm)	Inner Ctn.	EDP No.
1.5	4	79	160×45×5	10	143897
2	5	86	160×45×5	10	143898
2.5	6	94	200×60×8	10	143899
3	8	101	200×60×8	10	143900
4	9	110	200×60×8	10	143901
5	11	120	200×60×8	10	143902
6	13	133	200×60×8	10	143903
8	16	154	235×75×14	5	143904
10	19	172	235×75×14	5	143905

### No. 8200BP-L Ball Point Wrench Stubby (Long Type) **NEW**

- New ball shape with the maximum tilted angle of 38° (design value in our company).
  - Stubby ideal for cramped spaces
  - L-shape angle 95° for easy handling.
- The arm length is half of the standard arm size.



No.8200BP-L

Size (mm)	Ball Dia (mm)	Ball Dia (mm)	Package Size (mm)	Inner Ctn.	EDP No.
1.5	4	79	160×45×5	10	143907
2	5	95	200×60×8	10	143908
2.5	6	110	200×60×8	10	143909
3	8	126	200×60×8	10	143910
4	9	142	200×60×8	10	143911
5	11	160	235×75×14	5	143912
6	13	180	235×75×14	5	143913
8	16	200	280×65×14	5	143914
10	19	224	350×75×14	5	143915

### No. 8209BP-S Ball Point Wrench Stubby (Short Type) 9PC Set **NEW**

- New ball shape with the maximum tilted angle of 38° (design value in our company).
  - Stubby ideal for cramped spaces
  - L-shape angle 95° for easy handling.
- The arm length is half of the standard arm size.
- Provided with a convenient portable holder.
- This is openable facilitating to pick a necessary size.

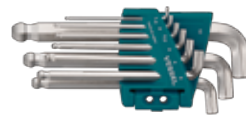
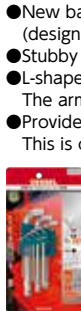

No.8209BP-S

Set content		Package size (mm)	Inner Ctn.	EDP No.
8209BP-S	H 1.5, 2, 2.5, 3, 4, 5, 6, 8, 10 mm			
Accessory	Holder	200×105×27	5	143896

### No. 8209BP Ball Point Wrench Stubby 9PC Set **NEW**

- New ball shape with the maximum tilted angle of 38° (design value in our company).
  - Stubby ideal for cramped spaces
  - L-shape angle 95° for easy handling.
- The arm length is half of the standard arm size.
- Provided with a convenient portable holder.
- This is openable facilitating to pick a necessary size.



No.8209BP

Set content		Package size (mm)	Inner Ctn.	EDP No.
8209BP	H 1.5, 2, 2.5, 3, 4, 5, 6, 8, 10 mm			
Accessory	Holder	245×105×27	5	143906

### No. 8209BP-L Ball Point Wrench Stubby (Long Type) 9PC Set **NEW**

- New ball shape with the maximum tilted angle of 38° (design value in our company).
  - Stubby ideal for cramped spaces
  - L-shape angle 95° for easy handling.
- The arm length is half of the standard arm size.
- Provided with a convenient portable holder.
- This is openable facilitating to pick a necessary size.



No.8209BP-L

Set content		Package size (mm)	Inner Ctn.	EDP No.
8209BP-L	H 1.5, 2, 2.5, 3, 4, 5, 6, 8, 10 mm			
Accessory	Holder	295×105×27	10	143916

## No. 8300BP Ball Point Wrench **NEW**



- New ball shape with the maximum tilted angle of 38° (design value in our company).



[ ] (mm)			Package Size (mm)	Inner Ctn.	EDP No.
1.5	16	79	160×45×5	10	143917
2	17	86	160×45×5	10	143918
2.5	18	94	200×60×8	10	143919
3	20	101	200×60×8	10	143920
4	25	110	200×60×8	10	143921
5	28	120	200×60×8	10	143922
6	32	133	200×60×8	10	143923
8	36	154	235×75×14	5	143924
10	40	172	235×75×14	5	143925

## No. 8309BP Ball Point Wrench 9PC Set **NEW**

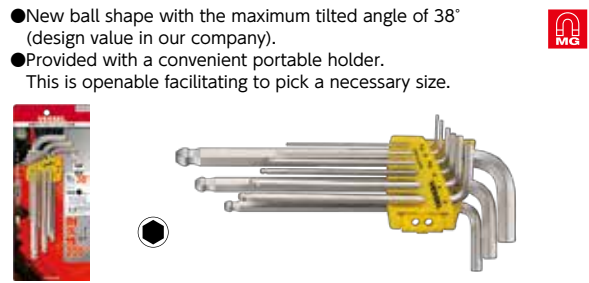

- New ball shape with the maximum tilted angle of 38° (design value in our company).
- Provided with a convenient portable holder. This is openable facilitating to pick a necessary size.



Set content		Package size (mm)	Inner Ctn.	EDP No.
8309BP	H 1.5, 2, 2.5, 3, 4, 5, 6, 8, 10 mm	245×105×27	5	143926
Accessory	Holder			

## No. 8300BP-L Ball Point Wrench (Long Type) **NEW**

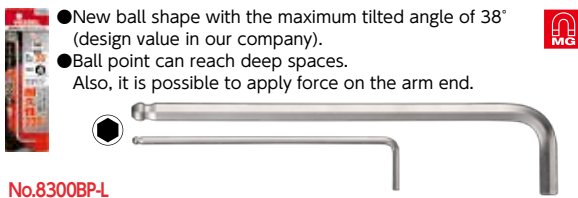

- New ball shape with the maximum tilted angle of 38° (design value in our company).
- Ball point can reach deep spaces. Also, it is possible to apply force on the arm end.



[ ] (mm)			Package Size (mm)	Inner Ctn.	EDP No.
1.5	16	79	160×45×5	10	143927
2	17	95	200×60×8	10	143928
2.5	18	110	200×60×8	10	143929
3	20	126	200×60×8	10	143930
4	25	142	200×60×8	10	143931
5	28	160	235×75×14	5	143932
6	32	180	235×75×14	5	143933
8	36	200	280×65×14	5	143934
10	40	224	350×75×14	5	143935
12	45	250	No Card	-	143936
14	55	280	No Card	-	143937
17	60	320	No Card	-	143938
19	70	360	No Card	-	143939

## No. 8309BP-L Ball Point Wrench (Long Type) 9PC Set **NEW**

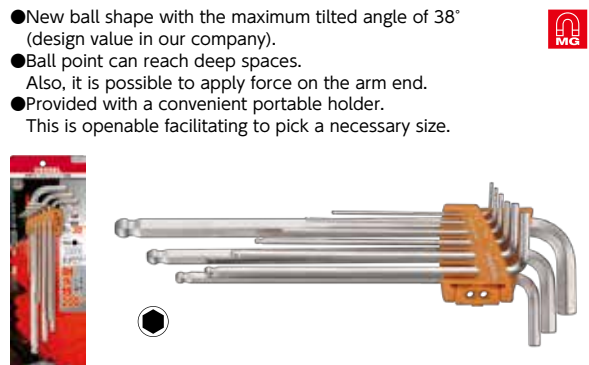

- New ball shape with the maximum tilted angle of 38° (design value in our company).
- Ball point can reach deep spaces. Also, it is possible to apply force on the arm end.
- Provided with a convenient portable holder. This is openable facilitating to pick a necessary size.



Set content		Package size (mm)	Inner Ctn.	EDP No.
8309BP-L	H 1.5, 2, 2.5, 3, 4, 5, 6, 8, 10 mm	295×105×27	10	143940
Accessory	Holder			

## No. 8300BP-XL Ball Point Wrench (Extra Long Type) **NEW**

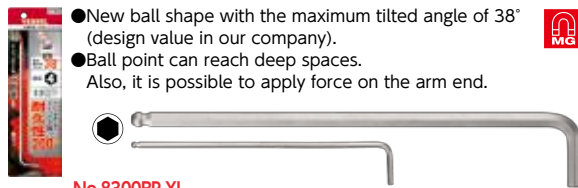

- New ball shape with the maximum tilted angle of 38° (design value in our company).
- Ball point can reach deep spaces. Also, it is possible to apply force on the arm end.



[ ] (mm)			Package Size (mm)	Inner Ctn.	EDP No.
1.5	16	91	160×45×5	10	143951
2	17	109	200×60×8	10	143952
2.5	18	132	200×60×8	10	143953
3	20	151	200×60×8	10	143954
4	25	170	235×75×14	5	143955
5	28	200	280×65×14	5	143956
6	32	225	280×65×14	5	143957
8	36	260	350×75×14	5	143958
10	40	291	350×75×14	5	143959

## No. 8309BP-XL Ball Point Wrench (Extra Long Type) 9PC Set **NEW**

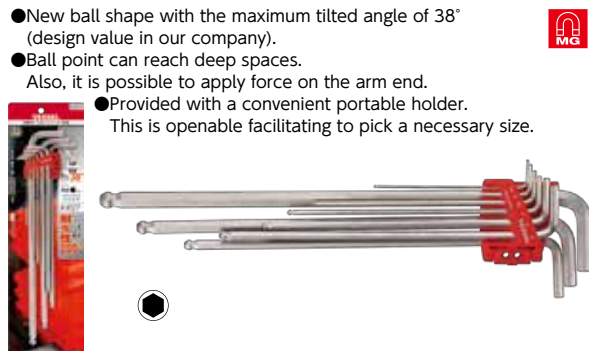

- New ball shape with the maximum tilted angle of 38° (design value in our company).
- Ball point can reach deep spaces. Also, it is possible to apply force on the arm end.
- Provided with a convenient portable holder. This is openable facilitating to pick a necessary size.



Set content		Package size (mm)	Inner Ctn.	EDP No.
8309BP-XL	H 1.5, 2, 2.5, 3, 4, 5, 6, 8, 10 mm	350×105×27	10	143960
Accessory	Holder			

HAND TOOLS

BITS & SOCKETS

ELECTRIC TOOLS

AIR TOOLS

STATIC SOLUTIONS

GASOLINE ENGINE TOOLS

### No. 8300BP-LIN Ball Point Wrench (Long Type) (Inch) **NEW**



- New ball shape with the maximum tilted angle of 38° (design value in our company).
- Ball point can reach deep spaces.  
Also, it is possible to apply force on the arm end.



No.8300BP-LIN

	⊙	┌	└	(mm)	Package Size (mm)	Inner Ctn.	EDP No.
1/16	15	79			160×45×5	10	143941
5/64	17	93			200×60×8	10	143942
3/32	18	108			200×60×8	10	143943
1/8	20	127			200×60×8	10	143944
5/32	25	140			200×60×8	10	143945
3/16	28	158			235×75×14	5	143946
1/4	32	178			235×75×14	5	143947
5/16	36	198			280×65×14	5	143948
3/8	40	222			350×75×14	5	143949

### No. 8309BP-LIN Ball Point Wrench (Long Type) (Inch) 9PC Set **NEW**



- New ball shape with the maximum tilted angle of 38° (design value in our company).
- Ball point can reach deep spaces.  
Also, it is possible to apply force on the arm end.
- Provided with a convenient portable holder.  
This is openable facilitating to pick a necessary size.



No.8309BP-LIN

Set content		Package size (mm)	Inner Ctn.	EDP No.
8309BP-LIN	A/F 1/16, 5/64, 3/32, 1/8, 5/32, 3/16, 1/4, 5/16, 3/8 inch	295×105×20	10	143950
Accessory	Holder			

### No. 8500BTX Ball End TORX Wrench **NEW**



- Can tighten screws quickly at a tilted angle. Ideal for a work in a cramped space such as automotive maintenance.



No.8500BTX

	⊙	┌	└	(mm)	Package Size (mm)	Inner Ctn.	EDP No.
T8	16	80			160×45×5	10	143961
T9	16	80			160×45×5	10	143962
T10	17	90			160×45×5	10	143963
T15	18	100			200×60×8	10	143964
T20	19	112			200×60×8	10	143965
T25	20	126			200×60×8	10	143966
T27	25	140			200×60×8	10	143967
T30	28	160			235×75×14	5	143968
T40	32	180			235×75×14	5	143969

### No. 8509BTX Ball End TORX Wrench 9PC Set **NEW**



- Can tighten screws quickly at a tilted angle. Ideal for a work in a cramped space such as automotive maintenance.
- Provided with a convenient portable holder.  
This is openable facilitating to pick a necessary size.



No.8509BTX

Set content		Package size (mm)	Inner Ctn.	EDP No.
8509BTX	Size T8, T9, T10, T15, T20, T25, T27, T30, T40 mm	245×105×27	5	143970
Accessory	Holder			

### No. 8500TXH Tamper-proof TORX Wrench **NEW**



- Can be used with tamper-proof screws. Automotive, Motorcycle, Telecommunication devices, PC, etc.



No.8500TXH

	⊙	┌	└	(mm)	Package Size (mm)	Inner Ctn.	EDP No.
T8H	16	80			160×45×5	10	143971
T9H	16	80			160×45×5	10	143972
T10H	17	90			160×45×5	10	143973
T15H	18	100			200×60×8	10	143974
T20H	19	112			200×60×8	10	143975
T25H	20	126			200×60×8	10	143976
T27H	25	140			200×60×8	10	143977
T30H	28	160			235×75×14	5	143978
T40H	32	180			235×75×14	5	143979

### No. 8509TXH Tamper-proof TORX Wrench 9PC Set **NEW**

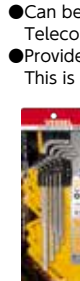

- Can be used with tamper-proof screws. Automotive, Motorcycle, Telecommunication devices, PC, etc.
- Provided with a convenient portable holder.  
This is openable facilitating to pick a necessary size.



No.8509TXH

Set content		Package size (mm)	Inner Ctn.	EDP No.
8509TXH	Size T8H, T9H, T10H, T15H, T20H, T25H, T27H, T30H, T40H mm	245×105×27	5	143980
Accessory	Holder			

**No. TW-H T-Handle Screwdriver NEW**



No.TW-H

I				(mm)	Inner Ctn.	EDP No.
3	125	70	163	6	144361	
4	140	70	178	6	144362	
5	150	80	200	6	144363	
6	155	120	223	-	144364	
8	175	160	251	-	144365	
10	200	160	276	-	144366	

**No. TW-HIN T-Handle Screwdriver (Inch) NEW**

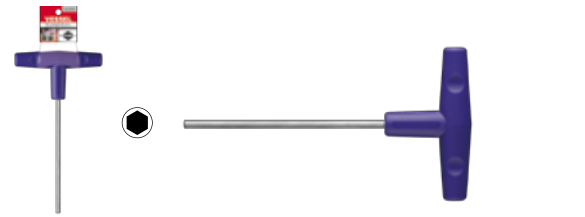

No.TW-HIN

I				(mm)	Inner Ctn.	EDP No.
1/8	125	70	163	6	144367	
5/32	140	70	178	6	144368	
3/16	150	80	200	6	144369	
1/4	155	120	223	-	144370	
5/16	175	160	251	-	144371	
3/8	200	160	276	-	144372	

**No. FW-H Flag Handle Screwdriver NEW**



No.TW-H

I				(mm)	Inner Ctn.	EDP No.
1.5	40	20	74	10	144373	
2	40	20	74	10	144374	
2.5	40	20	74	10	144375	

**No. FW-HIN Flag Handle Screwdriver (Inch) NEW**



No.FW-HIN

I				(mm)	Inner Ctn.	EDP No.
1/16	40	20	74	10	144376	
5/64	40	20	74	10	144377	
3/32	40	20	74	10	144378	

**No. 8300HX-S Hex Wrench (Short Type) NEW**



No.8300HX-S

I			(mm)	Inner Ctn.	EDP No.
1.5	12.5	52.5	10	144060	
2	12	58	10	144061	
2.5	15	60	10	144062	
3	20	65	10	144063	
4	25	72	10	144064	
5	28	80	10	144065	
6	32	90	10	144066	
8	36	100	5	144067	
10	40	112	5	144068	

HAND TOOLS  
BITS & SOCKETS  
ELECTRIC TOOLS  
AIR TOOLS  
STATIC SOLUTIONS  
GASOLINE ENGINE TOOLS

### No. 8900BP "RAINBALL" L-wrenches PAT.

- Easy to find in a toolbox. Color-coded by size. Coating is peel-proofed by manganese phosphate under coating.
- New ball shape. Set the driving part so that it contacts near the entry point of the hexagonal hole, with the maximum tilted angle of 38° (design value in our company). The cross-sectional area of the neck of the ball is enlarged to improve the strength.
- High precision black point tip, unaffected by metal plating.
- Cross-section is "Ultra-Hex", which has the 3-point and 3-surface contact geometry to reduce deforming of screw holes.



No.8900BP	Package size (mm)	Inner Ctn.	EDP No.
H 1.5	1.5 13.5 67.5	10	144341
H 2	2 15.5 72	10	144342
H 2.5	2.5 17.5 81	10	144343
H 3	3 19 90.5	10	144344
H 4	4 24 98.5	10	144345
H 5	5 27 118.5	10	144346
H 6	6 31 138	10	144347
H 8	8 35 158	5	144348
H 10	10 39 178.5	5	144349

※Colors inside the table cells indicate the body color.

### No. 8409BP "ULTRABALL" L-wrenches 9PC Set PAT.

- New ball shape with the maximum tilted angle of 38° (design value in our company). The cross-sectional area of the neck of the ball is enlarged to improve the strength.
- Cross-section is "Ultra-Hex", which has the 3-point and 3-surface contact geometry to reduce deforming of screw holes.
- Provided with a convenient portable holder. This is openable facilitating to pick a necessary size.



Set content		Package size (mm)	Inner Ctn.	EDP No.
8400BP	H 1.5, 2, 2.5, 3, 4, 5, 6, 8, 10 mm	245×105×27	5	144353
Accessory	Holder			

### No. 8906BP "RAINBALL" L-wrenches 6PC Set PAT.

- Easy to find in a toolbox. Color-coded by size.
- New ball shape with the maximum tilted angle of 38° (design value in our company). The cross-sectional area of the neck of the ball is enlarged to improve the strength.
- Provided with a convenient portable holder.



Set content		Package size (mm)	Inner Ctn.	EDP No.
8900BP	H 1.5, 2, 2.5, 3, 4, 5 mm	200×80×13	5	144352
Accessory	Holder			

### No. 8909BP "RAINBALL" L-wrenches 9PC Set PAT.

- Provided with a holder that opens like a fan and utilized as a stand, together with a magnetizer.
- The magnetizer can be taken out from the holder and used to magnetize and demagnetize a wrench.

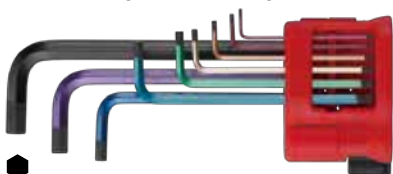

Set content		Package size (mm)	Inner Ctn.	EDP No.
8900BP	H 1.5, 2, 2.5, 3, 4, 5, 6, 8, 10 mm	245×105×27	5	144351
Accessory	Magnetizer/Holder			

## One point

### No.8409BP Ultra Ball

Unique ball configuration allowing the tip to incline 38° maximum facilitates tightening or loosening of screws!



Maximum Tilting angle 38° (designed value)

Open-folded holder is convenient for carrying the hex wrenches.

### Ultra Hex

Highly durable but no damage on screw surface! 3-point and 3-face contact hexagonal shape maximizes fastening effectiveness.



**No. 8500TX TORX Key Wrench**

- Special plating to keep precision at the tip.
- Knurled shank for fast turning.
- Precision tips based on TORX spec.



No.8500TX	I *				Package size (mm)	Inner Ctn.	EDP No.
T6	1.68	2.5	15	52	110×45×5	10	144301
T7	1.97	2.5	15	56	110×45×5	10	144302
T8	2.3	3	17	59	110×45×5	10	144303
T9	2.48	3	17	63	110×45×5	10	144304
T10	2.72	3	17	67	110×45×5	10	144305
T15	3.26	3.5	19	72	110×45×5	10	144306
T20	3.84	4	21	77	110×45×5	10	144307
T25	4.4	5	23	83	145×55×8	10	144308
T27	4.96	5	23	90	145×55×8	10	144309
T30	5.49	6	25	98	145×55×8	10	144310
T40	6.6	7	27	107	145×55×8	10	144311

**No. 8507TX TORX 7-Piece Key Set**

- Special plating to keep precision at the tip.
- Knurled shank for fast turning.
- Precision tips based on TORX spec.



Set content		Package size (mm)	Inner Ctn.	EDP No.
8500TX	T10, T15, T20, T25, T27, T30, T40	135×65×17	10	144315
Accessory	Vinyl package			

**No. 5400TX Power Grip TORX Screwdriver**

- Champagne gold plating keeping the precise tip quality.
- Cellulose acetate resin grip. Ergonomic design.
- For working with tamper-proof screws (T5 and T6 excluded).



No.5400TX	I *	I *				Inner Ctn.	Outer Ctn.	EDP No.
T 5 × 80	1.42	80	2.5	17.0	155	12	60	122854
T 6 × 80	1.69	80	2.5	17.0	155	12	60	122855
T 7H × 80	1.97	80	2.5	17.0	155	12	60	122856
T 8H × 80	2.3	80	3.0	17.0	155	12	60	122857
T 9H × 80	2.48	80	3.0	17.0	155	12	60	122858
T10H × 80	2.72	80	3.0	17.0	155	12	60	122859
T15H × 80	3.26	80	3.5	28.0	177	6	60	122860
T20H × 120	3.84	120	4.0	28.0	217	6	60	122861
T25H × 120	4.4	120	5.0	31.8	224	6	60	122862
T27H × 120	4.96	120	5.0	31.8	224	6	60	122863
T30H × 120	5.49	120	6.0	35.6	235	6	60	122864
T40H × 120	6.6	120	7.0	35.6	235	6	60	122865

TORX® is a registered trademark of Acument TM Intellectual Properties, LLC (USA). VESSEL has a manufacturing license in Japan and selling same to the world.

One point

Features of TORX tool



Basic TORX consists of 6 ear-lobular shaped curves. Compared to hexagonal shape driver, TORX has higher drive effectiveness and transfers torque smoothly and accurately while eliminating "CAM-OUT".

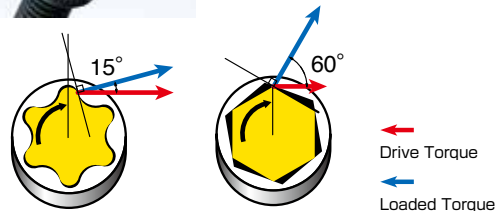

**TORX**  
TORX transfers max torque due to small driving angle.

**Hex**  
Meanwhile, Hex square drive need max upload torque to transfer for large diving angle to other directions.

**TAMPER-PROOF TORX SYSTEM**



Added function of "Never Touch Screw" a post in the middle of the recess for maximum security eliminates regular TORX drive or any other flat screwdrivers for safety. Tamper proof screws are mostly used at communication equipment and computers so as not to abuse the screwing/unscrewing due to its design and control of function Keep off unscrewing unless otherwise maintenance serving practiced.

TORX® is a registered trademark of Acument TM Intellectual Properties, LLC (USA). VESSEL has a manufacturing license in Japan and selling same to the world.

HAND TOOLS

BITS & SOCKETS

ELECTRIC TOOLS

AIR TOOLS

STATIC SOLUTIONS

GASOLINE ENGINE TOOLS



## No. TX-12MC Plate Ratchet/Magnetic Screw Catcher (TORX)



- Magnet catches a screw firmly.
- Also provided with Torx bits popular in the maintenance. Also used for tamper-proof torx screws.
- The speed ring enables you to turn a screw quickly. Removing the speed ring turn the product a 6.35mm hex drive.
- Bit insertion part ●6.35mm

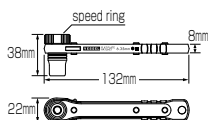

Set content		Package size (mm)	Inner Ctn.	EDP No.
Body	Plate ratchet screwdriver			
Bits	T8H, T10H, T15H, T20H, T25H, T27H, T30H, T40H, $\Phi 2$ , $\Phi 6 \times 25.4$ mm	190×85×27	10	252022
Accessory	Magnetic Screw Holder Bit belt holder			

## No. TX-11 Plate Ratchet TORX Set



- Storage holder included. For working with tamper-proof screws.
- The speed ring enables you to turn a screw quickly.
- Thin ratchet handle for working in cramped places. Ball locking system.
- Can be used with 6.35 mm across flats short bits and 6.35 mm square hole sockets.

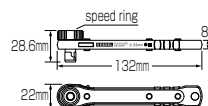

Set content		Package size (mm)	Inner Ctn.	EDP No.
Body	Plate ratchet screwdriver			
Bits	T8H, T10H, T15H, T20H, T25H, T27H, T30H, T40H, $\Phi 2$ , $\Phi 6 \times 25.4$ mm	190×85×27	10	252021
Accessory	Magnetic Screw Holder Bit belt holder			

TORX® is a registered trademark of Acument TM Intellectual Properties, LLC (USA). VESSEL has a manufacturing license in Japan and selling same to the world.

## No. B-340TX

### Wood-Compo TORX Screwdriver

PAT.



- Extraordinary non-slip grip: Secures working efficiency even with oily hands. Wood-composite resin, reproducing the natural material texture.
- Non-electrolytic plating, keeping the precise tip quality.
- Also good for tamper-proof TORX screws.



No.B-340TX						Inner Ctn.	Outer Ctn.	EDP No.
T10H× 80	2.72	80	5.5	30	188	6	120	120081
T15H× 80	3.26	80	5.5	30	188	6	120	120082
T20H×120	3.84	120	5.5	30	228	6	120	120083
T25H×120	4.40	120	6.4	32	236	6	60	120084
T27H×120	4.96	120	6.4	32	236	6	60	120085
T30H×120	5.49	120	8.0	35	246	6	60	120086
T40H×120	6.60	120	8.0	35	246	6	60	120087

TORX® is a registered trademark of Acument TM Intellectual Properties, LLC (USA). VESSEL has a manufacturing license in Japan and selling same to the world.

## No. B-640TX Cushion Grip TORX Screwdriver

- Optimal for fastening screws in precision fields.
- Non-electrolytic plating, keeping the precise tip quality.
- Cushion grip fitting comfortably in a hand.
- Also good for tamper-proof TORX screws (except T5 and T6).

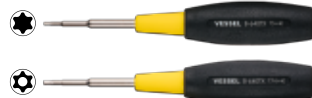

No.B-640TX						Inner Ctn.	Outer Ctn.	EDP No.
T5	1.42	40	4.0	20.5	126	6	60	123561
T6	1.69	40	4.0	20.5	126	6	60	123562
T7H	1.97	40	4.0	20.5	126	6	60	123563
T8H	2.30	40	4.0	20.5	126	6	60	123564
T9H	2.48	40	4.0	20.5	126	6	60	123565

TORX® is a registered trademark of Acument TM Intellectual Properties, LLC (USA). VESSEL has a manufacturing license in Japan and selling same to the world.

## No. TD-6310TX TORX Screwdriver Set

- Bit insertion part ●6.35mm. Magnetized.
- Holds securely short bits. Reliable fastening as the bit does not drop easily.
- Grip made of environmental-friendly plant material.
- Provided with a bit belt for storage.







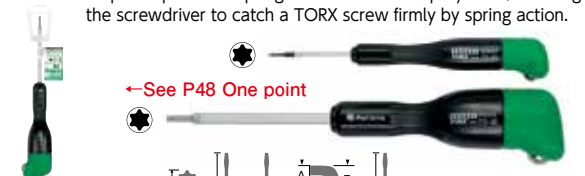

Set content		Package size (mm)	Outer Ctn.	EDP No.
Body	length 213mm dia. 28.5mm			
Bits	$\Phi 6$ , $\Phi 2$ , T8H, T10H, T15H, T20H, T25H, T27H, T30H, T40H $\times 25.4$ mm	235×100×29	10	247028
Accessories	Bit belt holder			

TORX® is a registered trademark of Acument TM Intellectual Properties, LLC (USA). VESSEL has a manufacturing license in Japan and selling same to the world.

**No. 990TX G-grip TORX Screwdriver PAT.**

- The weight of the steel ball keeps the end cap in an optimum position for a grip. 
- A special precision spring is welded to the tip by laser, enabling the screwdriver to catch a TORX screw firmly by spring action.



No.990TX							Inner Ctn.	Outer Ctn.	EDP No.
T3 × 40	1.13	40	2.5	16	21	138	12	240	125921
T5 × 40	1.42	40	2.5	16	21	138	12	240	125923
 T6 × 40	1.69	40	2.5	16	21	138	12	240	125924
 T8 × 40	2.3	40	2.5	16	21	138	12	240	125926
 T9 × 40	2.48	40	4.0	16	21	138	12	240	125927
 T10×80	2.72	80	4.0	30	38	195	6	60	125928
 T15×80	3.26	80	5.5	30	38	195	6	60	125929
 T20×80	3.84	80	5.5	30	38	195	6	60	125930

**No. TD-6816MG Ratchet Screwdriver (16-pc bit set)**

- Smoothly click feeling realized by rotating angle of 5° and 72 gears. High strength accomplished by 2 nails supporting the ratchet gear. It can be used for final tightening work. 
- The handle is made out of oil-resistance cellulose acetate resin.
- Easy to carry around with cassette type bit storage inside the handle.
- 16 types of bits to adapt to various types of work. Magnetic bits can be replaced with one-touch.
- Bit insertion part ●6.35mm.

Set content			
Body	length 177mm dia. 28.5mm		
Bits	⊕1, ⊕2, ⊕3, ⊖6, H2, H2.5, H3, H4, H5, T10H, T15H, T20H, T25H, T27H, T30H, T40H ×25.4mm		
Package size (mm)	Inner Ctn.	Outer Ctn.	EDP No.
235×90×29	5	30	247025

**No. TD-6808TX Ratchet Screwdriver TORX (8-pc bit set)**

- Smoothly click feeling realized by rotating angle of 5° and 72 gears. High strength accomplished by 2 nails supporting the ratchet gear. It can be used for final tightening work. 
- The handle is made out of oil-resistance cellulose acetate resin.
- Easy to carry around with cassette type bit storage inside the handle.
- Stores 8 types of bits including TORX bit. Magnetic bits can be replaced with one-touch.
- Bit insertion part ●6.35mm.

Set content			
Body	length 177mm dia. 28.5mm		
Bits	⊕2, ⊕3, T10H, T15H, T20H, T25H, T30H, T40H ×25.4mm		
Package size (mm)	Inner Ctn.	Outer Ctn.	EDP No.
235×80×29	5	30	247024

**No. TD-BS3 Replacement Bit Set**





Applicable models  
 TD-70/TD-71/TD-72/TD-73MC/TD-80/TD-150/TD-160/S-12/S-13  
 TX-10/TX-11/TX-12MC/830MG-4/840/840L

Model No.	Set content	Package size (mm)	Inner Ctn.	EDP No.
TD-BS3	T10H, T15H, T20H, T25H, T30H ×25.4mm Bit belt holder	120×45×23	10	251302



TORX® is a registered trademark of Acument TM Intellectual Properties, LLC (USA). VESSEL has a manufacturing license in Japan and selling same to the world.

TORX is also available for bits.





**Industrial Bits Type A**

- No.V TORX Bit ..... P66
- No.V TORX Bit (Tamper-Proof) ..... P67
-  No.V5 TORX Bit ..... P68
- 

**Industrial Bits Type B**

- No.N TORX Bit ..... P71, P84
- No.N TORX Bit (Tamper-Proof) ..... P71, P84
-  No.J TORX Bit ..... P75
- No.J TORX Bit (Tamper-Proof) ..... P74
-  No.A5 TORX Bit ..... P76
- 

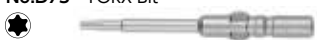
**Precision Bits**

- No.D573 Shockless Bit ..... P81
-  No.D71 TORX Bit ..... P82
-  No.D73 TORX Bit ..... P83
-  No.D76 TORX Bit ..... P84
- 

**Short Bits**

- No.A4 TORX Bit ..... P90
- 

**Construction Bits**

- No.SMVT TORX Bit (Tamper-Proof) ..... P108
- 

**"PROKON" series**

- No.SS16T Recessed "SAKISUBO" TORX Bit ..... P124
- 

TORX® is a registered trademark of Acument TM Intellectual Properties, LLC (USA). VESSEL has a manufacturing license in Japan and selling same to the world.

HAND TOOLS  
 BITS & SOCKETS  
 ELECTRIC TOOLS  
 AIR TOOLS  
 STATIC SOLUTIONS  
 GASOLINE ENGINE TOOLS

No. 3200VA-1

## VA cable stripper



The 3200VA-1 is a solution for stripping strenuous cables such as VA cables which becomes soft and elongates during the summer or as eco-friendly PE cables, which hardness during winter months.



**No. 3200VA-1**  
**VA cable stripper**

The depth of cut by blades can be adjusted by 5 levels to support the different hardness of coating for different wire manufacturers. Designed to hold the wire coating so that the core line is always at the center, to prevent jamming.

**No. 3200VA-1 VA cable stripper PAT.**

- Even for eco-friendly PE cables, clear stripping can be perfectly achieved with light force.
- Corresponds to various sheath hardness according to cable manufacturers. Can adjust cutting depth in 5 steps.
- Precision blades by the metal injection offer excellent cutting quality.
- Designed to hold wire sheath so that the core conductor is always located at the center, preventing the blades from cutting into the conductor.



← See P51



Model No.	Overall length (mm)	Weight (g)	Wire size	Outer Ctn.	EDP No.
3200VA-1	180	370	PVC cables (VVF/ VA cables) PE cables (EM-EEF/ Eco cables) φ1.6mm duplex/φ2.0mm duplex φ1.6mm triplex/φ2.0mm triplex	5	141016

Package size...250×115×63mm

**No. WB-013 For 3200VA-1 Replacement Blade**

Model No.	Applicable wire stripper	Package size (mm)	Inner Ctn.	EDP No.
WB-013	3200VA-1	120×45×3	10	141084

**No. 3000 Wire Stripper**

- Nimbly and cleanly strips off sheathing in a single operation.
- Can be used with wiring for TV, radio, home appliances, electrical work, automotive circuits, telephones, etc.
- With a strip gauge.



Model No.	Overall length (mm)	Weight (g)	Wire diameter and nominal sectional area	Handle color	Outer Ctn.	EDP No.
3000A	170	350	For solid wire 0.5/1.2/1.6/2.0mm	Green	20	141001
3000B	170	350	For solid wire 1.0/1.6/2.0/2.6/3.2mm	Red	20	141002
3000C	170	350	For stranded wire 0.9/1.25/2.0/3.5/5.5mm	Black	20	141000

Package size...220×75×13mm

**Wire Stripper Cardbord product**

Model No.	Wire diameter and nominal sectional area	Package size (mm)	Outer Ctn.	EDP No.
300001	For solid wire 0.5/1.2/1.6/2.0mm	250×110×38	5	241001
300002	For solid wire 1.0/1.6/2.0/2.6/3.2mm	250×110×38	5	241002
300005	For stranded wire 0.9/1.25/2.0/3.5/5.5mm	250×110×38	5	241005

**Wire Stripper Blade**

Model No.	Applicable wire stripper	Wire diameter and nominal sectional area	Package size (mm)	Inner Ctn.	EDP No.
WB-001	3000A, 300001	For solid wire	95×30×15	5	141071
WB-002	3000B, 300002	For solid wire	95×30×15	5	141072
WB-003	3000C, 300005	For stranded wire	95×30×15	5	141073

**No. 3700KS/KM Cable Stripper**



- Easy to strip the wire sheath simply by turning the stripper around the cable.
- Easy-handling non-slip pad on retaining hardware.
- Enables to adjust the cutting depth with a dial on the bottom.
- Light-weight and compact portable model.



Model No.	Overall length (mm)	Weight (g)	Strip Capacity	Inner Ctn.	EDP No.
3700KS	130	78	Seath φ4~16mm	10	141224
3700KM	130	78	Seath φ8~28mm	10	141225

Contents: Replacement blade 1piece (stored inside) Package size...185×75×32mm

**One point**

Easy to strip the wire sheath simply by turning the stripper around the cable.



**One point**

Features of wire strippers

**3200VA-1**



Wire strippers dedicated for VA cables and eco-friendly PE cables (VVF/EM-EEF)  
For solid wire 1.6mm×2/3duplex/triplex  
For solid wire 2.0mm×2/3duplex/triplex

**3000**



For stripping of various wires and cords including IV and VSF  
Solid wires: 0.5mm to 3.2mm  
Stranded wire: 0.9mm to 5.5mm

**3500E-1/3500E-2/3500E-3/3500E-4**



For cutting and stripping of various electronic wires represented by KV  
For solid wire 0.25mm~2.0mm  
For stranded wire 0.05mm~3.3mm

**3700KS/3700KM**



For stripping various cable sheaths such as cabtyre cable.  
Sheath outer dia. 4mm~16mm (3700KS)  
8mm~28mm (3700KM)

## No. 3500E-1/-2 Wire Stripper



- Lightweight (100g), compact handy type.
- Diamond finely polished blade for precision stripping.
- AWG-mm-mm<sup>2</sup> conversion table on the grip.



Model No.	Overall length (mm)	Weight (g)	Color	Inner Ctn.	Outer Ctn.	EDP No.
3500E-1	155	100	Red	5	30	141036
3500E-2	155	100	Yellow	5	30	141037

Package size...220x75x13mm

	AWG	12	14	16	18	20	22	24
3500E-1	Solid wire (mm)	2.0	1.6	1.3	1.0	0.8	0.65	0.5
	Stranded wire (mm <sup>2</sup> )	3.3	2.0	1.3	0.8	0.5	0.3	0.2
3500E-2	AWG	18	20	22	24	26	28	30
	Solid wire (mm)	1.0	0.8	0.65	0.5	0.4	0.3	0.25
	Stranded wire (mm <sup>2</sup> )	0.8	0.5	0.3	0.2	0.13	0.08	0.05

## No. 3500E-3/-4 Wire Stripper

- True circle shape. No damage on wires.
- Different colors adopted for instant awareness of holding position.
- Thread cutters for small screws or bolts.
- Anti-drop cord can be attached.
- AWG-mm-mm<sup>2</sup> conversion table on the cushion grip.



Model No.	Overall length (mm)	Weight (g)	Color	Inner Ctn.	Outer Ctn.	EDP No.
3500E-3	163	107	Red/Black	5	30	141013
3500E-4	163	107	Yellow/Black	5	30	141014

Cardboard size: 220x75x13mm

	AWG	12	14	16	18	20	22	24
3500E-3	Solid wire (mm)	2.0	1.6	1.3	1.0	0.8	0.65	0.5
	Stranded wire (mm <sup>2</sup> )	3.3	2.0	1.3	0.8	0.5	0.3	0.2
3500E-4	AWG	18	20	22	24	26	28	30
	Solid wire (mm)	1.0	0.8	0.65	0.5	0.4	0.3	0.25
	Stranded wire (mm <sup>2</sup> )	0.8	0.5	0.3	0.2	0.13	0.08	0.05

\* Some Teflon wires are not suitable.

## One point



**No. DB-200 Bucket for Electricians**

- Convenient for collecting wire scraps and carrying tools and instruments.
- Belt length can be adjusted.
- Elliptical shape to fit comfortably.



Size with header (mm)	Outer Ctn.	EDP No.
H280 x W200 x D125	1	141034

**No. 76-10 Gel Grip Hammer (Plastic Head)**

- Gel resin grip drastically absorbs the shocks by hammer blows to your palm. Alleviates the strain on your wrist.
- Slip resistance grip design of elastomer resin.
- Excellent balance between both heads, ensuring firm feeling of hammering.
- Hammer heads are screwed on and replaced easily. Replacement head is available as option.



Model No.	Size	Length	Head Diameter	Head Length (mm)	Weight (g)	Inner Ctn.	Outer Ctn.	EDP No.
<b>76-10</b>	1	315	32	120	430	6	60	142082

**Replacement Head for No.76 (Plastic Head)**

Model No.	Set content	Package size (mm)	Inner Ctn.	Outer Ctn.	EDP No.
<b>076110</b> Card Product	1lb x 2pcs	170x60x35	-	5	242024
<b>76-10H</b> Boxed	1lb	130x155x35	20	400	142131

\*Apply hammer Gel Grip Hammer No.76-10 No.77-10 Plastic Head Hammer No.70-1



**No. 70 Plastic Head Hammer**

- Soft durable plastic head. Does not damage workpieces.
- Replacement head is available as option in a box.
- Replacement head of 1/2, 1 and 1 1/2 sizes is also available in 2-pc pre-carded package.



To replace the hammer head

Size	Length	Head		Inner Ctn.	Outer Ctn.	EDP No.
		Diameter	Length (mm)			
<b>1/4</b>	280	19.5	66.5	6	60	142001
<b>1/2</b>	280	25	82	6	60	142002
<b>1</b>	295	31.3	108	6	60	142003
<b>1 1/2</b>	325	37.6	125.5	6	36	142004
<b>2</b>	350	45.4	139	6	24	142005

Handles are not separately sold.

**Replacement head for No.70**

Model No.	Set content	Package size (mm)	Inner Ctn.	Outer Ctn.	EDP No.
<b>Head 70x1/4</b>	1/4	85x102x20	20	-	142011
<b>Head 70x1/2</b>	1/2	110x132x27	20	400	142012
<b>Head 70x1</b>	1	130x155x35	20	400	142013
<b>Head 70x1 1/2</b>	1 1/2	80x185x42	10	400	142014
<b>Head 70x2</b>	2	100x225x48	10	400	142015

**Replacement head for No.70 Cardbord Products**

Model No.	Set content	Package size (mm)	Outer Ctn.	EDP No.
<b>070105</b>	1/2x2pcs	170x60x26	5	242012
<b>070110</b>	1x2pcs	170x60x35	5	242013
<b>070115</b>	1 1/2x2pcst	210x75x41	5	242014

⚠ WARNING concerning Hammers

- Strike target directly. Do not hit at an angle, etc.
- Do not strike anywhere but the target area.



**No. 77-10 Gel Grip Hammer (Rubber/Plastic Head)**

- Gel resin grip drastically absorbs the shocks by hammer blows to your palm. Alleviates the strain on your wrist.
- Slip resistance grip design of elastomer resin.
- Excellent balance between both heads, ensuring firm feeling of hammering.
- Hammer heads are screwed on and replaced easily. Replacement head is available as option.
- The hammer heads are screwed on and replaced easily. Rubber head is available as option. Rubber head is of light gray color, which does not cause color staining to the object.



Model No.	Size	Length	Head Diameter	Head Length (mm)	Weight (g)	Inner Ctn.	Outer Ctn.	EDP No.
<b>77-10</b>	1	315	32	120	430	6	60	142091

**Replacement Head for No.77 (Rubber Head)**

Model No.	Set content	Package size (mm)	Inner Ctn.	Outer Ctn.	EDP No.
<b>077110</b> Card Product	1lb x 2pcs	170x60x35	-	5	242021
<b>77-10H</b> Boxed	1lb	130x155x35	20	400	142121

\*Apply hammer Gel Grip Hammer No.77-10 Cannot be used for plastic hammer No.70-1.



**One point**

**GEL resin grip**



**GEL**

**Built-in gel cushions the shock to the palm**

Cushions the shock to the palm of hammering blows. Alleviates the strain on your wrist.

**Slip-resistant grip design**

By gel, the contact surface with the palm increases. Non-slip grip with projected parts.



HAND TOOLS

BITS & SOCKETS

ELECTRIC TOOLS

AIR TOOLS

STATIC SOLUTIONS

GASOLINE ENGINE TOOLS

### No. RG-95 Ratchet Rivet Gun



- Can calk blind rivets easily with one hand.
- Easily calks 4.8 mm steel rivets that were difficult to use with existing manual riveters.



Set content		Package size (mm)	Outer Ctn.	EDP No.
Body	overall length 230mm weight 570g			
Accessories	Nose piece 2.4, 3.2, 4.0, 4.8mm Nose piece wrench A/F10mm			

### No. 8 Thread File

- Quickly restores threads of tooling machines, automobiles, etc.
- 1 tool can be used with 8 different thread pitches.

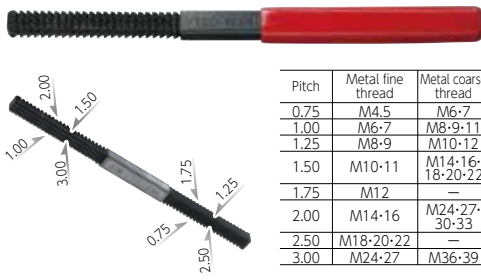

Pitch	Metal fine thread	Metal coarse thread
0.75	M4.5	M6-7
1.00	M6-7	M8-9-11
1.25	M8-9	M10-12
1.50	M10-11	M14-16-18-20-22
1.75	M12	—
2.00	M14-16	M24-27-30-33
2.50	M18-20-22	—
3.00	M24-27	M36-39

Set content		Package size (mm)	Outer Ctn.	EDP No.
Pitch (mm)	0.75 / 1.00 / 1.25 / 1.50 1.75 / 2.00 / 2.50 / 3.00			

### No. 5700WP Water Faucet Screwdriver



- Large sized tip enables stable fastening work as it fits well.

Cr-V Steel



Set content		Package size (mm)	Inner Ctn.	EDP No.
18	1.6			
85	8			
30	134.5			

### No. 5700BD Car Battery Screwdriver



- Special coin-shaped drive tip with A/F 10mm hexagonal opening.
- Handle color changes depending on viewing angle.

Cr-V Steel



Set content		Package size (mm)	Inner Ctn.	EDP No.
18	10			
1.6	85			
8	28.5			
133				

### No. ZW-3/ZW-4 Thread Thru Stud Wrench

- Works with continuous thread studs, cut bolts and hanger bolts.
- Can be used 2 ways: Straight for tightening, or bent for fast turning.
- Can be used from halfway point with long hanger bolts.
- Lightweight, compact and easy to carry.



		Weight (mm) (g)	Package size (mm)	Inner Ctn.	EDP No.
ZW-3	Thread part: 3/8	32 20 140	224	195×64×27	10 621320
ZW-4	Thread part: 1/2	32 20 140	222	195×64×27	10 621321

## One point

### Features of special tools



#### Ratchet Rivet Gun

Allows you to caulk blind rivets easily with one hand



#### Thread File

For restoring of screw threads  
One file can be used for eight different thread pitches.



#### Thread Thru Stud Wrench

Dedicated for installing a full-thread bolt  
It can be bent to turn a bolt quickly.



#### Water Faucet Screwdriver

Used for tightening and loosening of a water shut-off valve, flow-regulating valve, or check valve



#### Car Battery Screwdriver

It is a combination of a spanner with width across flats of 10mm for car battery removal and a coin-shaped drive tip.