

No. 8209BP

"BALL POINT" L-wrenches



Inclining the wrench moves the driving points toward the entry of the hexagon screw head recess. Even if the neck place of the ball point is thick, the wrench can be inclined up to 38°, the maximum tilting angle.

Magnetized tip can retain a hexagon screw head bolt.

Constricted neck design with hexagonal shape enables to retain a hexagon screw head bolt firmly. Easy to replace bolts located in a deep place.

Resistant to twist and breaking Extra Superalloy

Made in Japan (except 8300HX-S)

With our new L-Wrench technology and design you will be able to perform the final tightening of your work even with the ball point shape.

One point TORX Wrench Series

Quick tightening at tilted angle.

Max Tilting Angle **25°**
(Designed value)

Ball-shaped TORX wrench. Can tighten screws quickly at a tilted angle. Ideal for a work in a cramped space such as automotive maintenance.



Can be used with tamper-proof screws.

Tamper-proof TORX screw has a protrusion in the center of the screw recess, and a standard TORX screwdriver cannot tighten or loosen such screw.

*Screws with a protrusion different from the standard TORX cannot be handled.



TORX® Tip-end processing based on TORX standards. Corresponds to various screws.

No. 8209BP
"BALL POINT"
Wrench
Stubby 9-PC Set

L-shape angle 95° for easy handling. The arm length is half of the standard arm size.

HAND TOOLS

BITS & SOCKETS

ELECTRIC TOOLS

AIR TOOLS

STATIC SOLUTIONS

GASOLINE ENGINE TOOLS

No. 8200BP-S Ball Point Wrench Stubby (Short Type) **NEW**



- New ball shape with the maximum tilted angle of 38° (design value in our company).
 - Stubby ideal for cramped spaces
 - L-shape angle 95° for easy handling.
- The arm length is half of the standard arm size.



No.8200BP-S

Size (mm)	Length (mm)	Width (mm)	Package Size (mm)	Inner Ctn.	EDP No.
1.5	4	52	160×45×5	10	143887
2	5	58	160×45×5	10	143888
2.5	6	60	160×45×5	10	143889
3	8	65	160×45×5	10	143890
4	9	72	200×60×8	10	143891
5	11	80	200×60×8	10	143892
6	13	90	200×60×8	10	143893
8	16	100	235×75×14	5	143894
10	19	112	235×75×14	5	143895

No. 8200BP Ball Point Wrench Stubby **NEW**



- New ball shape with the maximum tilted angle of 38° (design value in our company).
 - Stubby ideal for cramped spaces
 - L-shape angle 95° for easy handling.
- The arm length is half of the standard arm size.



No.8200BP

Size (mm)	Length (mm)	Width (mm)	Package Size (mm)	Inner Ctn.	EDP No.
1.5	4	79	160×45×5	10	143897
2	5	86	160×45×5	10	143898
2.5	6	94	200×60×8	10	143899
3	8	101	200×60×8	10	143900
4	9	110	200×60×8	10	143901
5	11	120	200×60×8	10	143902
6	13	133	200×60×8	10	143903
8	16	154	235×75×14	5	143904
10	19	172	235×75×14	5	143905

No. 8200BP-L Ball Point Wrench Stubby (Long Type) **NEW**



- New ball shape with the maximum tilted angle of 38° (design value in our company).
 - Stubby ideal for cramped spaces
 - L-shape angle 95° for easy handling.
- The arm length is half of the standard arm size.



No.8200BP-L

Size (mm)	Length (mm)	Width (mm)	Package Size (mm)	Inner Ctn.	EDP No.
1.5	4	79	160×45×5	10	143907
2	5	95	200×60×8	10	143908
2.5	6	110	200×60×8	10	143909
3	8	126	200×60×8	10	143910
4	9	142	200×60×8	10	143911
5	11	160	235×75×14	5	143912
6	13	180	235×75×14	5	143913
8	16	200	280×65×14	5	143914
10	19	224	350×75×14	5	143915

No. 8209BP-S Ball Point Wrench Stubby (Short Type) 9PC Set **NEW**

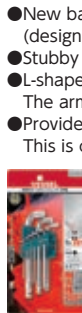

- New ball shape with the maximum tilted angle of 38° (design value in our company).
 - Stubby ideal for cramped spaces
 - L-shape angle 95° for easy handling.
- The arm length is half of the standard arm size.
- Provided with a convenient portable holder.
- This is openable facilitating to pick a necessary size.

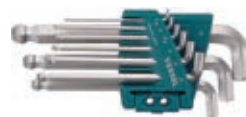

No.8209BP-S

Set content		Package size (mm)	Inner Ctn.	EDP No.
8209BP-S	H 1.5, 2, 2.5, 3, 4, 5, 6, 8, 10 mm	200×105×27	5	143896
Accessory	Holder			

No. 8209BP Ball Point Wrench Stubby 9PC Set **NEW**

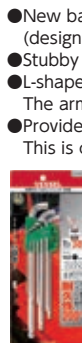

- New ball shape with the maximum tilted angle of 38° (design value in our company).
 - Stubby ideal for cramped spaces
 - L-shape angle 95° for easy handling.
- The arm length is half of the standard arm size.
- Provided with a convenient portable holder.
- This is openable facilitating to pick a necessary size.



No.8209BP

Set content		Package size (mm)	Inner Ctn.	EDP No.
8209BP	H 1.5, 2, 2.5, 3, 4, 5, 6, 8, 10 mm	245×105×27	5	143906
Accessory	Holder			

No. 8209BP-L Ball Point Wrench Stubby (Long Type) 9PC Set **NEW**



- New ball shape with the maximum tilted angle of 38° (design value in our company).
 - Stubby ideal for cramped spaces
 - L-shape angle 95° for easy handling.
- The arm length is half of the standard arm size.
- Provided with a convenient portable holder.
- This is openable facilitating to pick a necessary size.



No.8209BP-L

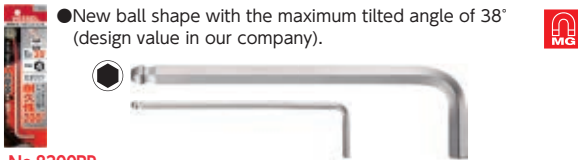

Set content		Package size (mm)	Inner Ctn.	EDP No.
8209BP-L	H 1.5, 2, 2.5, 3, 4, 5, 6, 8, 10 mm	295×105×27	10	143916
Accessory	Holder			

No. 8300BP Ball Point Wrench **NEW**



- New ball shape with the maximum tilted angle of 38° (design value in our company).



   (mm)			Package Size (mm)	Inner Ctn.	EDP No.
1.5	16	79	160×45×5	10	143917
2	17	86	160×45×5	10	143918
2.5	18	94	200×60×8	10	143919
3	20	101	200×60×8	10	143920
4	25	110	200×60×8	10	143921
5	28	120	200×60×8	10	143922
6	32	133	200×60×8	10	143923
8	36	154	235×75×14	5	143924
10	40	172	235×75×14	5	143925

No. 8309BP Ball Point Wrench 9PC Set **NEW**



- New ball shape with the maximum tilted angle of 38° (design value in our company).
- Provided with a convenient portable holder. This is openable facilitating to pick a necessary size.





Set content		Package size (mm)	Inner Ctn.	EDP No.
8309BP	H 1.5, 2, 2.5, 3, 4, 5, 6, 8, 10 mm	245×105×27	5	143926
Accessory	Holder			

No. 8300BP-L Ball Point Wrench (Long Type) **NEW**



- New ball shape with the maximum tilted angle of 38° (design value in our company).
- Ball point can reach deep spaces. Also, it is possible to apply force on the arm end.



   (mm)			Package Size (mm)	Inner Ctn.	EDP No.
1.5	16	79	160×45×5	10	143927
2	17	95	200×60×8	10	143928
2.5	18	110	200×60×8	10	143929
3	20	126	200×60×8	10	143930
4	25	142	200×60×8	10	143931
5	28	160	235×75×14	5	143932
6	32	180	235×75×14	5	143933
8	36	200	280×65×14	5	143934
10	40	224	350×75×14	5	143935
12	45	250	No Card	-	143936
14	55	280	No Card	-	143937
17	60	320	No Card	-	143938
19	70	360	No Card	-	143939

No. 8309BP-L Ball Point Wrench (Long Type) 9PC Set **NEW**



- New ball shape with the maximum tilted angle of 38° (design value in our company).
- Ball point can reach deep spaces. Also, it is possible to apply force on the arm end.
- Provided with a convenient portable holder. This is openable facilitating to pick a necessary size.





Set content		Package size (mm)	Inner Ctn.	EDP No.
8309BP-L	H 1.5, 2, 2.5, 3, 4, 5, 6, 8, 10 mm	295×105×27	10	143940
Accessory	Holder			

No. 8300BP-XL Ball Point Wrench (Extra Long Type) **NEW**



- New ball shape with the maximum tilted angle of 38° (design value in our company).
- Ball point can reach deep spaces. Also, it is possible to apply force on the arm end.



   (mm)			Package Size (mm)	Inner Ctn.	EDP No.
1.5	16	91	160×45×5	10	143951
2	17	109	200×60×8	10	143952
2.5	18	132	200×60×8	10	143953
3	20	151	200×60×8	10	143954
4	25	170	235×75×14	5	143955
5	28	200	280×65×14	5	143956
6	32	225	280×65×14	5	143957
8	36	260	350×75×14	5	143958
10	40	291	350×75×14	5	143959

No. 8309BP-XL Ball Point Wrench (Extra Long Type) 9PC Set **NEW**

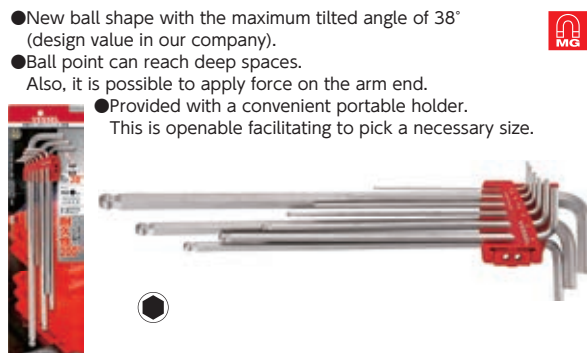

- New ball shape with the maximum tilted angle of 38° (design value in our company).
- Ball point can reach deep spaces. Also, it is possible to apply force on the arm end.
- Provided with a convenient portable holder. This is openable facilitating to pick a necessary size.



Set content		Package size (mm)	Inner Ctn.	EDP No.
8309BP-XL	H 1.5, 2, 2.5, 3, 4, 5, 6, 8, 10 mm	350×105×27	10	143960
Accessory	Holder			

HAND TOOLS
BITS & SOCKETS
ELECTRIC TOOLS
AIR TOOLS
STATIC SOLUTIONS
GASOLINE ENGINE TOOLS

No. 8300BP-LIN Ball Point Wrench (Long Type) (Inch) **NEW**



- New ball shape with the maximum tilted angle of 38° (design value in our company).
- Ball point can reach deep spaces. Also, it is possible to apply force on the arm end.



No.8300BP-LIN

Size	Length (mm)	Width (mm)	Package Size (mm)	Inner Ctn.	EDP No.
1/16	15	79	160×45×5	10	143941
5/64	17	93	200×60×8	10	143942
3/32	18	108	200×60×8	10	143943
1/8	20	127	200×60×8	10	143944
5/32	25	140	200×60×8	10	143945
3/16	28	158	235×75×14	5	143946
1/4	32	178	235×75×14	5	143947
5/16	36	198	280×65×14	5	143948
3/8	40	222	350×75×14	5	143949

No. 8309BP-LIN Ball Point Wrench (Long Type) (Inch) 9PC Set **NEW**

- New ball shape with the maximum tilted angle of 38° (design value in our company).
- Ball point can reach deep spaces. Also, it is possible to apply force on the arm end.
- Provided with a convenient portable holder. This is openable facilitating to pick a necessary size.



No.8309BP-LIN

Set content		Package size (mm)	Inner Ctn.	EDP No.
8309BP-LIN	A/F 1/16, 5/64, 3/32, 1/8, 5/32, 3/16, 1/4, 5/16, 3/8 inch	295×105×20	10	143950
Accessory	Holder			

No. 8500BTX Ball End TORX Wrench **NEW**



- Can tighten screws quickly at a tilted angle. Ideal for a work in a cramped space such as automotive maintenance.



No.8500BTX

Size	Length (mm)	Width (mm)	Package Size (mm)	Inner Ctn.	EDP No.
T8	16	80	160×45×5	10	143961
T9	16	80	160×45×5	10	143962
T10	17	90	160×45×5	10	143963
T15	18	100	200×60×8	10	143964
T20	19	112	200×60×8	10	143965
T25	20	126	200×60×8	10	143966
T27	25	140	200×60×8	10	143967
T30	28	160	235×75×14	5	143968
T40	32	180	235×75×14	5	143969

No. 8509BTX Ball End TORX Wrench 9PC Set **NEW**

- Can tighten screws quickly at a tilted angle. Ideal for a work in a cramped space such as automotive maintenance.
- Provided with a convenient portable holder. This is openable facilitating to pick a necessary size.



No.8509BTX

Set content		Package size (mm)	Inner Ctn.	EDP No.
8509BTX	Size T8, T9, T10, T15, T20, T25, T27, T30, T40 mm	245×105×27	5	143970
Accessory	Holder			

No. 8500TXH Tamper-proof TORX Wrench **NEW**



- Can be used with tamper-proof screws. Automotive, Motorcycle, Telecommunication devices, PC, etc.



No.8500TXH

Size	Length (mm)	Width (mm)	Package Size (mm)	Inner Ctn.	EDP No.
T8H	16	80	160×45×5	10	143971
T9H	16	80	160×45×5	10	143972
T10H	17	90	160×45×5	10	143973
T15H	18	100	200×60×8	10	143974
T20H	19	112	200×60×8	10	143975
T25H	20	126	200×60×8	10	143976
T27H	25	140	200×60×8	10	143977
T30H	28	160	235×75×14	5	143978
T40H	32	180	235×75×14	5	143979

No. 8509TXH Tamper-proof TORX Wrench 9PC Set **NEW**

- Can be used with tamper-proof screws. Automotive, Motorcycle, Telecommunication devices, PC, etc.
- Provided with a convenient portable holder. This is openable facilitating to pick a necessary size.



No.8509TXH

Set content		Package size (mm)	Inner Ctn.	EDP No.
8509TXH	Size T8H, T9H, T10H, T15H, T20H, T25H, T27H, T30H, T40H mm	245×105×27	5	143980
Accessory	Holder			

No. TW-H T-Handle Screwdriver NEW



No.TW-H

Hex Size	Length (mm)	Width (mm)	Depth (mm)	Inner Ctn. (mm)	EDP No.
3	125	70	163	6	144361
4	140	70	178	6	144362
5	150	80	200	6	144363
6	155	120	223	-	144364
8	175	160	251	-	144365
10	200	160	276	-	144366

No. TW-HIN T-Handle Screwdriver (Inch) NEW



No.TW-HIN

Hex Size	Length (mm)	Width (mm)	Depth (mm)	Inner Ctn. (mm)	EDP No.
1/8	125	70	163	6	144367
5/32	140	70	178	6	144368
3/16	150	80	200	6	144369
1/4	155	120	223	-	144370
5/16	175	160	251	-	144371
3/8	200	160	276	-	144372

No. FW-H Flag Handle Screwdriver NEW



No.TW-H

Hex Size	Length (mm)	Width (mm)	Depth (mm)	Inner Ctn. (mm)	EDP No.
1.5	40	20	74	10	144373
2	40	20	74	10	144374
2.5	40	20	74	10	144375

No. FW-HIN Flag Handle Screwdriver (Inch) NEW



No.FW-HIN

Hex Size	Length (mm)	Width (mm)	Depth (mm)	Inner Ctn. (mm)	EDP No.
1/16	40	20	74	10	144376
5/64	40	20	74	10	144377
3/32	40	20	74	10	144378

No. 8300HX-S Hex Wrench (Short Type) NEW



No.8300HX-S

Hex Size	Length (mm)	Depth (mm)	Inner Ctn. (mm)	EDP No.
1.5	12.5	52.5	10	144060
2	12	58	10	144061
2.5	15	60	10	144062
3	20	65	10	144063
4	25	72	10	144064
5	28	80	10	144065
6	32	90	10	144066
8	36	100	5	144067
10	40	112	5	144068

HAND TOOLS
BITS & SOCKETS
ELECTRIC TOOLS
AIR TOOLS
STATIC SOLUTIONS
GASOLINE ENGINE TOOLS

No. 8900BP "RAINBALL" L-wrenches PAT.

- Easy to find in a toolbox. Color-coded by size. Coating is peel-proofed by manganese phosphate under coating.
- New ball shape. Set the driving part so that it contacts near the entry point of the hexagonal hole, with the maximum tilted angle of 38° (design value in our company). The cross-sectional area of the neck of the ball is enlarged to improve the strength.
- High precision black point tip, unaffected by metal plating.
- Cross-section is "Ultra-Hex", which has the 3-point and 3-surface contact geometry to reduce deforming of screw holes.



No.8900BP	Set content	Package size (mm)	Inner Ctn.	EDP No.
H 1.5	1.5 13.5 67.5	160×45×5	10	144341
H 2	2 15.5 72	160×45×5	10	144342
H 2.5	2.5 17.5 81	160×45×5	10	144343
H 3	3 19 90.5	160×45×5	10	144344
H 4	4 24 98.5	200×60×8	10	144345
H 5	5 27 118.5	200×60×8	10	144346
H 6	6 31 138	200×60×8	10	144347
H 8	8 35 158	235×75×14	5	144348
H 10	10 39 178.5	235×75×14	5	144349

※Colors inside the table cells indicate the body color.

No. 8409BP "ULTRABALL" L-wrenches 9PC Set PAT.

- New ball shape with the maximum tilted angle of 38° (design value in our company). The cross-sectional area of the neck of the ball is enlarged to improve the strength.
- Cross-section is "Ultra-Hex", which has the 3-point and 3-surface contact geometry to reduce deforming of screw holes.
- Provided with a convenient portable holder. This is openable facilitating to pick a necessary size.



Set content		Package size (mm)	Inner Ctn.	EDP No.
8400BP	H 1.5, 2, 2.5, 3, 4, 5, 6, 8, 10 mm	245×105×27	5	144353
Accessory	Holder			

No. 8906BP "RAINBALL" L-wrenches 6PC Set PAT.

- Easy to find in a toolbox. Color-coded by size.
- New ball shape with the maximum tilted angle of 38° (design value in our company). The cross-sectional area of the neck of the ball is enlarged to improve the strength.
- Provided with a convenient portable holder.



Set content		Package size (mm)	Inner Ctn.	EDP No.
8900BP	H 1.5, 2, 2.5, 3, 4, 5 mm	200×80×13	5	144352
Accessory	Holder			

No. 8909BP "RAINBALL" L-wrenches 9PC Set PAT.

- Provided with a holder that opens like a fan and utilized as a stand, together with a magnetizer.
- The magnetizer can be taken out from the holder and used to magnetize and demagnetize a wrench.

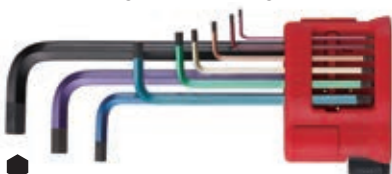

Set content		Package size (mm)	Inner Ctn.	EDP No.
8900BP	H 1.5, 2, 2.5, 3, 4, 5, 6, 8, 10 mm	245×105×27	5	144351
Accessory	Magnetizer/Holder			

One point

No.8409BP Ultra Ball

Unique ball configuration allowing the tip to incline 38° maximum facilitates tightening or loosening of screws!

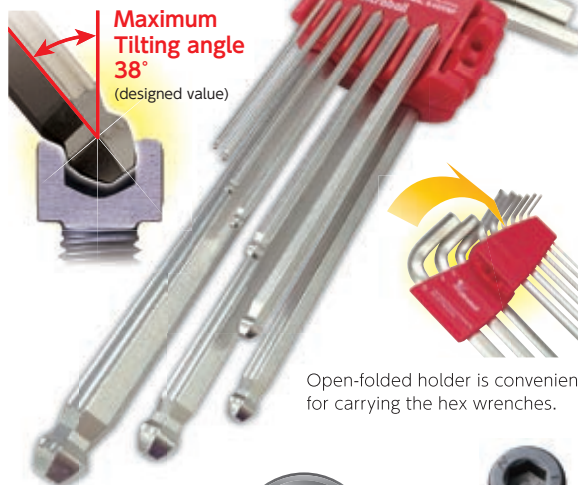

Ultra Hex

Highly durable but no damage on screw surface! 3-point and 3-face contact hexagonal shape maximizes fastening effectiveness.



No. 8500TX TORX Key Wrench

- Special plating to keep precision at the tip.
- Knurled shank for fast turning.
- Precision tips based on TORX spec.



No.8500TX	I *				Package size (mm)	Inner Ctn.	EDP No.
T6	1.68	2.5	15	52	110×45×5	10	144301
T7	1.97	2.5	15	56	110×45×5	10	144302
T8	2.3	3	17	59	110×45×5	10	144303
T9	2.48	3	17	63	110×45×5	10	144304
T10	2.72	3	17	67	110×45×5	10	144305
T15	3.26	3.5	19	72	110×45×5	10	144306
T20	3.84	4	21	77	110×45×5	10	144307
T25	4.4	5	23	83	145×55×8	10	144308
T27	4.96	5	23	90	145×55×8	10	144309
T30	5.49	6	25	98	145×55×8	10	144310
T40	6.6	7	27	107	145×55×8	10	144311

No. 8507TX TORX 7-Piece Key Set

- Special plating to keep precision at the tip.
- Knurled shank for fast turning.
- Precision tips based on TORX spec.



Set content		Package size (mm)	Inner Ctn.	EDP No.
8500TX	T10, T15, T20, T25, T27, T30, T40	135×65×17	10	144315
Accessory	Vinyl package			

No. 5400TX Power Grip TORX Screwdriver

- Champagne gold plating keeping the precise tip quality.
- Cellulose acetate resin grip. Ergonomic design.
- For working with tamper-proof screws (T5 and T6 excluded).



No.5400TX	I *	I *				Inner Ctn.	Outer Ctn.	EDP No.
T 5 × 80	1.42	80	2.5	17.0	155	12	60	122854
T 6 × 80	1.69	80	2.5	17.0	155	12	60	122855
T 7H× 80	1.97	80	2.5	17.0	155	12	60	122856
T 8H× 80	2.3	80	3.0	17.0	155	12	60	122857
T 9H× 80	2.48	80	3.0	17.0	155	12	60	122858
T10H× 80	2.72	80	3.0	17.0	155	12	60	122859
T15H× 80	3.26	80	3.5	28.0	177	6	60	122860
T20H× 120	3.84	120	4.0	28.0	217	6	60	122861
T25H× 120	4.4	120	5.0	31.8	224	6	60	122862
T27H× 120	4.96	120	5.0	31.8	224	6	60	122863
T30H× 120	5.49	120	6.0	35.6	235	6	60	122864
T40H× 120	6.6	120	7.0	35.6	235	6	60	122865

TORX® is a registered trademark of Acument TM Intellectual Properties, LLC (USA). VESSEL has a manufacturing license in Japan and selling same to the world.

One point

Features of TORX tool



Basic TORX consists of 6 ear-lobular shaped curves. Compared to hexagonal shape driver, TORX has higher drive effectiveness and transfers torque smoothly and accurately while eliminating "CAM-OUT".

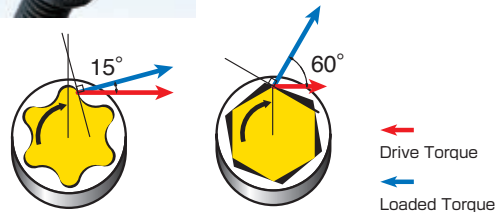

TORX
TORX transfers max torque due to small driving angle.

Hex
Meanwhile, Hex square drive need max upload torque to transfer for large diving angle to other directions.

TAMPER-PROOF TORX SYSTEM



Added function of "Never Touch Screw" a post in the middle of the recess for maximum security eliminates regular TORX drive or any other flat screwdrivers for safety. Tamper proof screws are mostly used at communication equipment and computers so as not to abuse the screwing/unscrewing due to its design and control of function Keep off unscrewing unless otherwise maintenance serving practiced.

TORX® is a registered trademark of Acument TM Intellectual Properties, LLC (USA). VESSEL has a manufacturing license in Japan and selling same to the world.

HAND TOOLS

BITS & SOCKETS

ELECTRIC TOOLS

AIR TOOLS

STATIC SOLUTIONS

GASOLINE ENGINE TOOLS

No. TX-12MC Plate Ratchet/Magnetic Screw Catcher (TORX)



- Magnet catches a screw firmly.
- Also provided with Torx bits popular in the maintenance. Also used for tamper-proof torx screws.
- The speed ring enables you to turn a screw quickly. Removing the speed ring turn the product a 6.35mm hex drive.
- Bit insertion part ●6.35mm

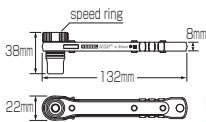

Set content		Package size (mm)	Inner Ctn.	EDP No.
Body	Plate ratchet screwdriver			
Bits	T8H, T10H, T15H, T20H, T25H, T27H, T30H, T40H, $\Phi 2$, $\Phi 6 \times 25.4$ mm	190×85×27	10	252022
Accessory	Magnetic Screw Holder Bit belt holder			

No. TX-11 Plate Ratchet TORX Set



- Storage holder included. For working with tamper-proof screws.
- The speed ring enables you to turn a screw quickly.
- Thin ratchet handle for working in cramped places. Ball locking system.
- Can be used with 6.35 mm across flats short bits and 6.35 mm square hole sockets.

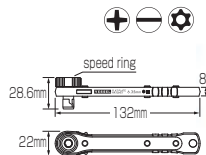

Set content		Package size (mm)	Inner Ctn.	EDP No.
Body	Plate ratchet screwdriver			
Bits	T8H, T10H, T15H, T20H, T25H, T27H, T30H, T40H, $\Phi 2$, $\Phi 6 \times 25.4$ mm	190×85×27	10	252021
Accessory	Magnetic Screw Holder Bit belt holder			

TORX® is a registered trademark of Acument TM Intellectual Properties, LLC (USA). VESSEL has a manufacturing license in Japan and selling same to the world.

No. B-340TX

Wood-Compo TORX Screwdriver

PAT.



- Extraordinary non-slip grip: Secures working efficiency even with oily hands. Wood-composite resin, reproducing the natural material texture.
- Non-electrolytic plating, keeping the precise tip quality.
- Also good for tamper-proof TORX screws.



No.B-340TX						Inner Ctn.	Outer Ctn.	EDP No.
T10H× 80	2.72	80	5.5	30	188	6	120	120081
T15H× 80	3.26	80	5.5	30	188	6	120	120082
T20H×120	3.84	120	5.5	30	228	6	120	120083
T25H×120	4.40	120	6.4	32	236	6	60	120084
T27H×120	4.96	120	6.4	32	236	6	60	120085
T30H×120	5.49	120	8.0	35	246	6	60	120086
T40H×120	6.60	120	8.0	35	246	6	60	120087

TORX® is a registered trademark of Acument TM Intellectual Properties, LLC (USA). VESSEL has a manufacturing license in Japan and selling same to the world.

No. B-640TX Cushion Grip TORX Screwdriver

- Optimal for fastening screws in precision fields.
- Non-electrolytic plating, keeping the precise tip quality.
- Cushion grip fitting comfortably in a hand.
- Also good for tamper-proof TORX screws (except T5 and T6).



No.B-640TX						Inner Ctn.	Outer Ctn.	EDP No.
T5	1.42	40	4.0	20.5	126	6	60	123561
T6	1.69	40	4.0	20.5	126	6	60	123562
T7H	1.97	40	4.0	20.5	126	6	60	123563
T8H	2.30	40	4.0	20.5	126	6	60	123564
T9H	2.48	40	4.0	20.5	126	6	60	123565

TORX® is a registered trademark of Acument TM Intellectual Properties, LLC (USA). VESSEL has a manufacturing license in Japan and selling same to the world.

No. TD-6310TX TORX Screwdriver Set

- Bit insertion part ●6.35mm. Magnetized.
- Holds securely short bits. Reliable fastening as the bit does not drop easily.
- Grip made of environmental-friendly plant material.
- Provided with a bit belt for storage.









Set content		Package size (mm)	Outer Ctn.	EDP No.
Body	length 213mm dia. 28.5mm			
Bits	$\Phi 6$, $\Phi 2$, T8H, T10H, T15H, T20H, T25H, T27H, T30H, T40H ×25.4mm	235×100×29	10	247028
Accessories	Bit belt holder			

TORX® is a registered trademark of Acument TM Intellectual Properties, LLC (USA). VESSEL has a manufacturing license in Japan and selling same to the world.



No. 990TX G-grip TORX Screwdriver PAT.

- The weight of the steel ball keeps the end cap in an optimum position for a grip. 
- A special precision spring is welded to the tip by laser, enabling the screwdriver to catch a TORX screw firmly by spring action.



No.990TX							Inner Ctn.	Outer Ctn.	EDP No.
T3 × 40	1.13	40	2.5	16	21	138	12	240	125921
T5 × 40	1.42	40	2.5	16	21	138	12	240	125923
 T6 × 40	1.69	40	2.5	16	21	138	12	240	125924
 T8 × 40	2.3	40	2.5	16	21	138	12	240	125926
 T9 × 40	2.48	40	4.0	16	21	138	12	240	125927
 T10×80	2.72	80	4.0	30	38	195	6	60	125928
 T15×80	3.26	80	5.5	30	38	195	6	60	125929
 T20×80	3.84	80	5.5	30	38	195	6	60	125930

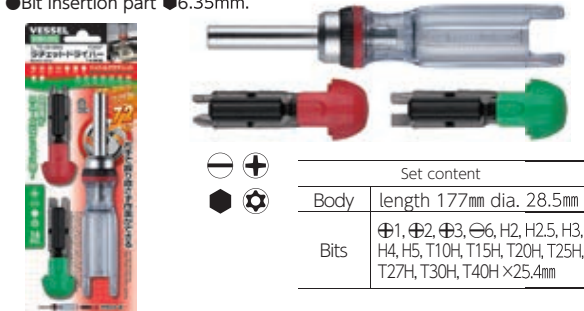

No. TD-6816MG Ratchet Screwdriver (16-pc bit set)

- Smoothly click feeling realized by rotating angle of 5° and 72 gears. High strength accomplished by 2 nails supporting the ratchet gear. It can be used for final tightening work.  
- The handle is made out of oil-resistance cellulose acetate resin.
- Easy to carry around with cassette type bit storage inside the handle.
- 16 types of bits to adapt to various types of work. Magnetic bits can be replaced with one-touch.
- Bit insertion part ●6.35mm.



Set content			
Body	length 177mm dia. 28.5mm		
Bits	Φ1, Φ2, Φ3, Φ6, H2, H2.5, H3, H4, H5, T10H, T15H, T20H, T25H, T27H, T30H, T40H ×25.4mm		
Package size (mm)	Inner Ctn.	Outer Ctn.	EDP No.
235×90×29	5	30	247025

No. TD-6808TX Ratchet Screwdriver TORX (8-pc bit set)

- Smoothly click feeling realized by rotating angle of 5° and 72 gears. High strength accomplished by 2 nails supporting the ratchet gear. It can be used for final tightening work.  
- The handle is made out of oil-resistance cellulose acetate resin.
- Easy to carry around with cassette type bit storage inside the handle.
- Stores 8 types of bits including TORX bit. Magnetic bits can be replaced with one-touch.
- Bit insertion part ●6.35mm.

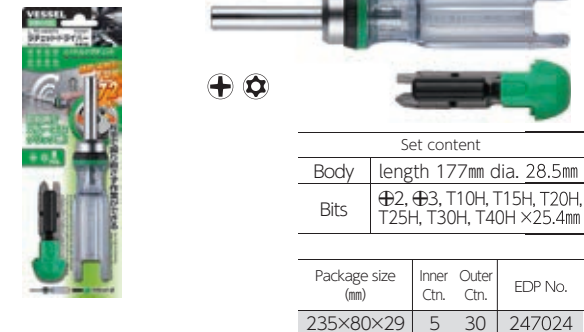

Set content			
Body	length 177mm dia. 28.5mm		
Bits	Φ2, Φ3, T10H, T15H, T20H, T25H, T30H, T40H ×25.4mm		
Package size (mm)	Inner Ctn.	Outer Ctn.	EDP No.
235×80×29	5	30	247024

No. TD-BS3 Replacement Bit Set

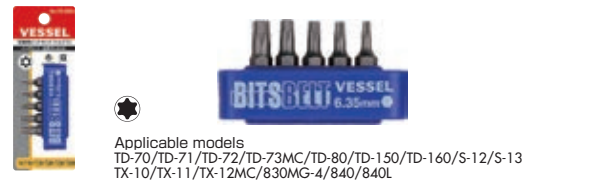

Applicable models
TD-70/TD-71/TD-72/TD-73MC/TD-80/TD-150/TD-160/S-12/S-13
TX-10/TX-11/TX-12MC/830MG-4/840/840L

Model No.	Set content	Package size (mm)	Inner Ctn.	EDP No.
TD-BS3	T10H, T15H, T20H, T25H, T30H ×25.4mm Bit belt holder	120×45×23	10	251302

TORX® is a registered trademark of Acument TM Intellectual Properties, LLC (USA). VESSEL has a manufacturing license in Japan and selling same to the world.

TORX is also available for bits.

Industrial Bits Type A

- No.V TORX Bit P66
- No.V TORX Bit (Tamper-Proof) P67
- No.V5 TORX Bit P68

Industrial Bits Type B

- No.N TORX Bit P71, P84
- No.N TORX Bit (Tamper-Proof) P71, P84
- No.J TORX Bit P75
- No.J TORX Bit (Tamper-Proof) P74
- No.A5 TORX Bit P76

Precision Bits

- No.D573 Shockless Bit P81
- No.D71 TORX Bit P82
- No.D73 TORX Bit P83
- No.D76 TORX Bit P84

Short Bits

- No.A4 TORX Bit P90

Construction Bits

- No.SMVT TORX Bit (Tamper-Proof) P108

"PROKON" series

- No.SS16T Recessed "SAKISUBO" TORX Bit P124

TORX® is a registered trademark of Acument TM Intellectual Properties, LLC (USA). VESSEL has a manufacturing license in Japan and selling same to the world.

HAND TOOLS
BITS & SOCKETS
ELECTRIC TOOLS
AIR TOOLS
STATIC SOLUTIONS
GASOLINE ENGINE TOOLS