

ENGLISH

VESSEL®

**INSTRUCTION MANUAL
AND
SAFETY INSTRUCTIONS
FOR
RECHARGEABLE BALLGRIP S/D
(SCREWDRIVER)**

No.220USB-1E

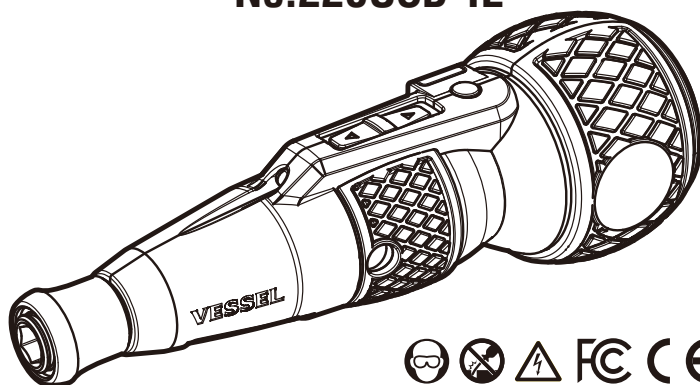

**Thank you for purchasing our Rechargeable Ballgrip Screwdriver
No.220USB-1E.**

Read this instruction manual before use.

Keep it in a safe handy place for future reference.

Contents

General power tool safety warnings-----	2
Safety warnings for screwdrivers-----	3
Package contents/ Intended use/ Features/ Specifications -----	4
Charging/ Changing the tool -----	5
Usage/ Maintenance and cleaning/ Disposal -----	6
Troubleshooting/ After-sales service -----	7
Declaration of Conformity -----	8

S/D means "Screwdriver".

DEFINITIONS: Safety Guidelines

The definitions below describe the level of severity for each signal word. Please read the manual and pay attention to these symbols.

⚠ **WARNING:** Indicates a potentially hazardous situation which, if not avoided, could result in death or serious injury.

⚠ **CAUTION:** Indicates a potentially hazardous situation which, if not avoided, may result in minor or moderate injury.

⚠ **NOTICE:** Indicates a practice not related to personal injury which, if not avoided, may result in property damage.

SYMBOLS



Use eye protection during operation.



Do not use a screwdriver as a pry bar, chisel, punch or hammer.



Protect the battery against heat, e.g., against continuous intense sunlight.



Risk of electric shock.



WARNING: To reduce the risk of injury, read the instruction manual.

GENERAL POWER TOOL SAFETY WARNINGS



WARNING: Read all safety warnings, instructions, illustrations and specifications provided with this power tool. Failure to follow all instructions listed below may result in electric shock, fire and/or serious injury.

Save all warnings and instructions for future reference. The term “power tool” in the warnings refers to your mains-operated (corded) power tool or battery-operated (cordless) power tool.

Work area safety

▶ **Keep work area clean and well lit.**

Cluttered or dark areas invite accidents.

▶ **Do not operate power tools in explosive atmospheres, such as in the presence of flammable liquids, gases or dust.** Power tools create sparks which may ignite the dust or fumes.

▶ **Keep children and bystanders away while operating a power tool.** Distractions can cause you to lose control.

Electrical safety



▶ **Power tool plugs must match the outlet. Never modify the plug in any way.**

Do not use any adapter plugs with earthed (grounded) power tools. Unmodified plugs and matching outlets will reduce risk of electric shock.

▶ **Avoid body contact with earthed or grounded surfaces, such as pipes, radiators, ranges and refrigerators.** There is an increased risk of electric shock if your body is earthed or grounded.

▶ **Do not expose power tools to rain or wet conditions.** Water entering a power tool will increase the risk of electric shock.

▶ **Do not abuse the cord. Never use the cord for carrying, pulling or unplugging the power tool. Keep cord away from heat, oil, sharp edges or moving parts.** Damaged or entangled cords increase the risk of electric shock.

▶ **When operating a power tool outdoors, use an extension cord suitable for outdoor use.** Use of a cord suitable for outdoor use reduces the risk of electric shock.

▶ **If operating a power tool in a damp location is unavoidable, use a residual current device (RCD) protected supply.** Use of an RCD reduces the risk of electric shock.

Personal safety

▶ **Stay alert, watch what you are doing and use common sense when operating a power tool. Do not use a power tool while you are tired or under the influence of drugs, alcohol or medication.** A moment of inattention while operating power tools may result in serious personal injury.



▶ **Use personal protective equipment. Always wear eye protection.** Protective equipment such as dust mask, non-skid safety shoes, hard hat, or hearing protection used for appropriate conditions will reduce personal injuries.

▶ **Prevent unintentional starting. Ensure the switch is in the off-position before connecting to power source and/or battery pack, picking up or carrying the tool.** Carrying power tools with your finger on the switch or energising power tools that have the switch on invites accidents.

▶ **Remove any adjusting key or wrench before turning the power tool on.** A wrench or a key left attached to a rotating part of the power tool may result in personal injury.

▶ **Do not overreach. Keep proper footing and balance at all times.** This enables better control of the power tool in unexpected situations.

▶ **Dress properly. Do not wear loose clothing or jewellery. Keep your hair and clothing away from moving parts.** Loose clothes, jewellery or long hair can be caught in moving parts.

▶ **If devices are provided for the connection of dust extraction and collection facilities, ensure**

these are connected and properly used. Use of dust collection can reduce dust-related hazards.

▶ **Do not let familiarity gained from frequent use of tools allow you to become complacent and ignore tool safety principles.** A careless action can cause severe injury within a fraction of a second.

Power tool use and care

▶ **Do not force the power tool. Use the correct power tool for your application.** The correct power tool will do the job better and safer at the rate for which it was designed.

▶ **Do not use the power tool if the switch does not turn it on and off.** Any power tool that cannot be controlled with the switch is dangerous and must be repaired.

▶ **Disconnect the plug from the power source and/or remove the battery pack, if detachable, from the power tool before making any adjustments, changing accessories, or storing power tools.** Such preventive safety measures reduce the risk of starting the power tool accidentally.

▶ **Store idle power tools out of the reach of children and do not allow persons unfamiliar with the power tool or these instructions to operate the power tool.** Power tools are dangerous in the hands of untrained users.

▶ **Maintain power tools and accessories. Check for misalignment or binding of moving parts, breakage of parts and any other condition that may affect the power tool's operation. If damaged, have the power tool repaired before use.** Many accidents are caused by poorly maintained power tools.

▶ **Keep cutting tools sharp and clean.** Properly maintained cutting tools with sharp cutting edges are less likely to bind and are easier to control.

▶ **Use the power tool, accessories and tool bits etc. in accordance with these instructions, taking into account the working conditions and the work to be performed.** Use of the power tool for operations different from those intended could result in a hazardous situation.

▶ **Keep handles and grasping surfaces dry, clean and free from oil and grease.** Slippery handles and grasping surfaces do not allow for safe handling and control of the tool in unexpected situations.

Battery tool use and care

▶ **Recharge only with the charger specified by the manufacturer.** A charger that is suitable for one type of battery pack may create a risk of fire when used with another battery pack.

▶ **Use power tools only with specifically des-**

igned battery packs. Use of any other battery packs may create a risk of injury and fire.

▶ **When battery pack is not in use, keep it away from other metal objects, like paper clips, coins, keys, nails, screws or other small metal objects, that can make a connection from one terminal to another.** Shorting the battery terminals together may cause burns or a fire.

▶ **Under abusive conditions, liquid may be ejected from the battery; avoid contact. If contact accidentally occurs, flush with water. If liquid contacts eyes, additionally seek medical help.** Liquid ejected from the battery may cause irritation or burns.

▶ **Do not use a battery pack or tool that is damaged or modified.** Damaged or modified batteries may exhibit unpredictable behaviour resulting in fire, explosion or risk of injury.

▶ **Do not expose a battery pack or tool to fire or excessive temperature.** Exposure to fire or temperature above 130°C may cause explosion.

▶ **Follow all charging instructions and do not charge the battery pack or tool outside the temperature range specified in the instructions.** Charging improperly or at temperatures outside the specified range may damage the battery and increase the risk of fire.

Service

▶ **Have your power tool serviced by a qualified repair person using only identical replacement parts.** This will ensure that the safety of the power tool is maintained.

▶ **Never service damaged battery packs.** Service of battery packs should only be performed by the manufacturer or authorized service providers.

SAFETY WARNINGS FOR SCREWDRIVERS



▶ **Do not use a screwdriver as a pry bar, chisel, punch or hammer.** Broken screwdriver can cause injury.

▶ **Hold power tool by insulated gripping surfaces, when performing an operation where the fastener may contact hidden wiring.** Fasteners contacting a "live" wire may make exposed metal parts of the power tool "live" and could give the operator an electric shock.

▶ **Hold the machine with a firm grip.** High reaction torque can briefly occur while driving in and loosening screws.

▶ **Secure the workpiece.** A workpiece clamped with clamping devices or in a vice is held more secure than by hand.

▶ **Always wait until the machine has come to a complete stop before placing it down.**

The tool insert can jam and lead to loss of control over the power tool.

► **Before any work on the machine (e. g., maintenance, tool change, etc.) as well as during transport and storage, set the rotational direction switch to the center position.** Unintentional actuation of the switch can lead to injuries.



► **Protect the battery against heat, e.g., against continuous intense sunlight, fire, water, and moisture.** Failure to do so may result in an explosion.

► **In case of damage and improper use of the battery, vapours may be emitted.** Ventilate the area and seek medical help in case of complaints. The vapours can irritate the respiratory system.

► **This product contains a lithium battery.** A lithium battery reaches its end of life after many years of use. To protect the environment, follow the treaties for ecological protection of local governments of your country to properly dispose of this battery.



Lithium-ion batteries are recyclable

PACKAGE CONTENTS

1 Power tool

1 Bit

1 USB Charging cable(1m)

1 Instruction manual

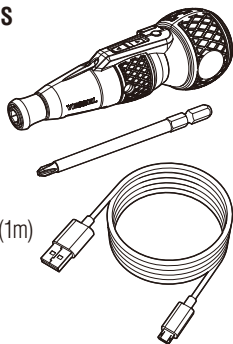

NAME OF PARTS

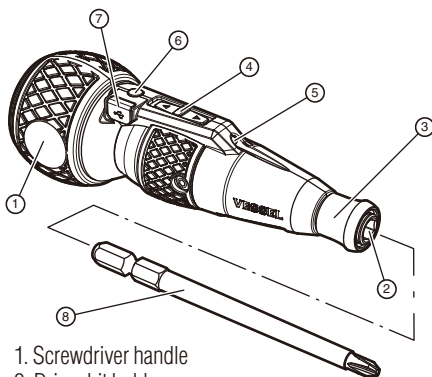

1. Screwdriver handle
2. Driver bit holder
3. Sleeve
4. Switch
5. LED light

6. Charging lamp
7. Charging port
8. Screwdriver bit

INTENDED USE

The 220USB is used for tightening and loosening screws. The 220USB is an electric screwdriver that can be charged by connecting a USB charging cable.

FEATURES

- Quick tightening can be performed efficiently with the aid of an electric motor. The final tightening is automatically switched to manual operation.
- The high-intensity LED light brightens the blade edge even in dark places.
- The switch is a slide switch that can be operated forward and backward with light force.
- Small and light with USB rechargeable Li-ion battery.
- Various commercially available bits of 6.35 mm are available.

TECHNICAL SPECIFICATIONS

- Rated voltage	3.6 V DC
- Capacity	800 mAh
No-load speed	280 min ⁻¹
Torque	
- Electric power (Max.)	2 N·m
- Hand operation (Max.)	10 N·m
Weight (not including accessories)	160 g
Permitted ambient temperature	
- during charging	0 °C - 40 °C
- operating* and storing	0 °C - 45 °C
Battery	Li-Ion
Number of battery cells	1
Charging time	Approx. 60 min
Number of charges**	Approx. 500 charges
Charging port	micro USB Type-B
Noise	66.1 dB
according to EN 62841-1 Annex I	
Vibration values	0.421 m/s ²
according to EN 62841-1 Annex I, EN 62841-2	
Input power (maximum) - Volt	5 V
- Current	1 A

* limited performance at temperatures <0 °C

**Actual battery life will vary depending on specifications.

- Specifications and sizes are subject to change without notice.

REPLACEABLE PARTS

- END CAP

- ALUMINIUM RING



SIZE

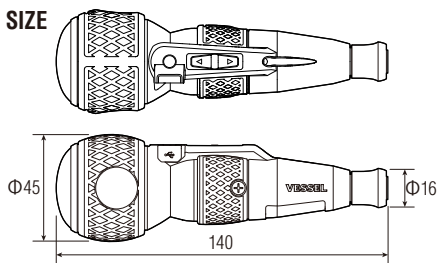

CHARGING

Use a charger with the specified charging capacity. (Output: 5 V-1 Amp)

If the current value is high, the life of the internal battery will be shortened.

* This product does not come with a charger.

1) Open the protective cap (see the figure on the right) of the power tool charging port and insert the USB charging cable.

Charging may not be possible if the USB charging cable is not correctly inserted into the charging port.

- Open after pulling out the cap.
- Use the USB charging cable included with this product.
- Opening from the reverse direction will cause a damage.

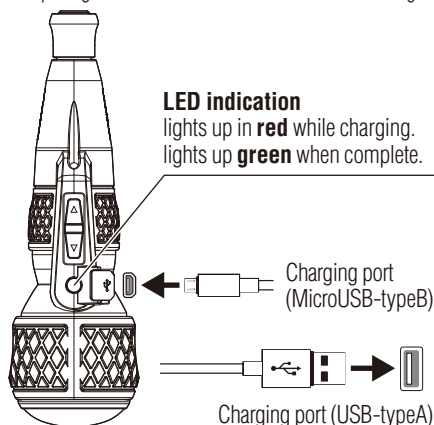
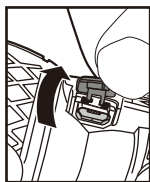

2) Insert the other end of the USB charging cable to a USB port designated in the specifications (commercially available AC adapters, PCs, mobile batteries, etc.). The charging lamp lights up and the charging starts. While charging the battery, the charging lamp lights red. When charging is complete, the charging lamp lights green.

Note: The battery supplied is partially charged. To ensure full capacity of the battery, completely charge the battery in the battery charger before using the product for the first time. The lithium-ion battery can be charged at any time without reducing its service life. Interrupting the charging procedure does not damage the battery. The Lithium-Ion battery is protected against deep discharging.

Note: If the charge level of the battery is less than 15%, the battery charge lamp will flash red during operation. When the battery voltage drops to the specified value, it cannot operate to protect the product. Stop work and charge the battery.

Note: The product cannot be used during charging. The screwdriver will not operate if the switch is sliding during charging - this is not a breakdown.

Note: If not used for a long time, disconnect the charger from main power.

3) When charging is complete, remove the USB charging cable and close the protective cap. Dirt and foreign matter may cause malfunction.

CHANGING THE TOOL

Only use the specified bits. If you use bits other than those specified, bits may not be possible to be removed.

- **Bits** that can be used are limited to products with the following mounting dimensions.

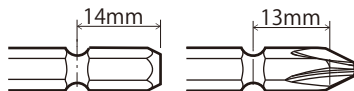

- **Inserting bit:** Slide the sleeve forward, insert the bit all the way in, and release the sleeve. Move the bit back and forth to make sure it is locked. Risk of injury if the bit comes off while operating.

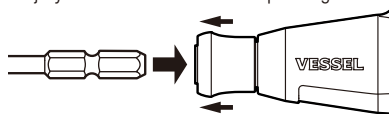

- **Removing bit:** Slide the sleeve forward, pull out the bit and release the sleeve. Be careful not to drop bits or the power tool when operating at height.

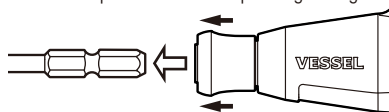

CAUTION: Do not slide the switch when inserting or removing bits. The power tool may operate and cause injury.

NORMAL ROTATION/ REVERSE ROTATION SWITCH

⚠ CAUTION: Do not keep pressing the switch after the power tool turns off automatically. Internal parts may be damaged.

The sliding direction of the switch on this product allows it to rotate in the desired rotation.

- **CW:** To rotate the spindle clockwise, slide the switch forward to rotate it, and the LED light will turn on at the same time. When you release your hand from the switch, the switch returns to the neutral position and rotation stops, but the LED light will turn off after 5 seconds.
- **CCW:** To rotate the spindle counterclockwise, slide the switch backward to rotate it, and the LED light will be turned on at the same time. When you release your hand from the switch, the switch returns to the neutral position and rotation stops, but the LED light will turn off after 5 seconds.

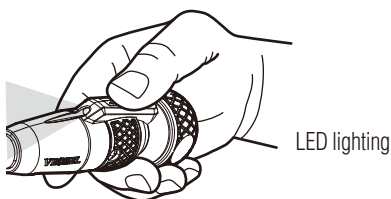
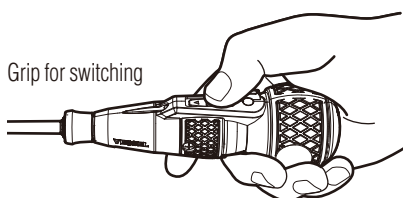
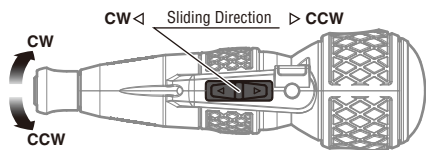

⚠ CAUTION: Do not look directly into the LED light. Your eyes could be damaged.

⚠ CAUTION: Continually carrying out heavy loads may cause malfunctions. If the work load is too heavy, the product protection function will be activated. When the product protection function is activated, the charging lamp blinks and the product does not operate.

- Fully automatic spindle locking (Auto-lock):

When the switch is in neutral position, turning the power tool manually will lock the spindle and tighten the screw. It allows the screw to be tightened even when the battery is empty, which allows the power tool to be used as a manual screwdriver.

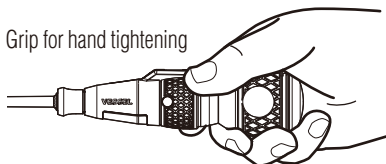

⚠ CAUTION: Do not slide the switch while the spindle is locked and the screw is manually tightened. The power tool may be damaged.

- Working advice:

Apply the power tool to the screw only when it is switched off. Rotating tool inserts can slip off.

MAINTENANCE AND CLEANING

Periodic inspection

- Loose screws, damage or malfunction.

⚠ CAUTION: Before any work (e. g., maintenance, tool change, etc.) as well as during transport and storage, set the rotational direction switch to the neutral position. Unintentional actuation of the switch can lead to injuries.

For safe and proper working, **always keep the tool clean.**

⚠ CAUTION: A reinforced plastic cover is used. Do not use detergents or the following chemicals to wipe the surface. Risk of cracks, electric shock, or failure. - Benzene, Thinner, Ketone, Ether and other similar chemicals

DISPOSAL

Do not dispose the power tool in your household waste! Take your tool to an authorized VESSEL agent where it will be disposed of in an environmentally safe way.



⚠ WARNING: Risk of fire or injury. Do not attempt to disassemble the battery or remove any component.

TROUBLESHOOTING

Problem	Possible causes	Solution
No rotation	Battery is not sufficiently charged	Charge battery.
	Breakdown of the switch, motor or circuit board	Contact the distributor where you made the purchase.
	Breakdown of internal parts	Contact the distributor where you made the purchase.
The power tool stops working during operation	Battery is not sufficiently charged	Charge battery.
	The power tool stops working due to protection circuit activation.	Increase the pause time.
Abnormal noise	Breakdown of motor and gear	Contact the distributor where you made the purchase.
Heat generation of power tool	Temperature increase due to overload	Increase the pause time.
	Breakdown of motor and circuit board	Contact the distributor where you made the purchase.
	Temperature increase due to charging in progress	Increase the charging pause time.
Bits cannot be inserted	The bits do not fit	Contact the distributor where you made the purchase.
	Breakdown of internal parts	Contact the distributor where you made the purchase.
Idling of the chuck	Breakdown of internal parts	Contact the distributor where you made the purchase.
Working LED does not light up	Breakdown of internal parts	Contact the distributor where you made the purchase.
Can't charge	Charger problem	Confirm whether the output of the connected charger is 5V 1A
Slow speed	Battery is not sufficiently charged	Charge battery.
	Breakdown of internal parts	Contact the distributor where you made the purchase.
When charging is complete, the green light and the red light are turned on alternately.	Product specification	Since it is a charging voltage control loop, it has no operating problem, so it can be used directly.
	Breakdown of internal parts	If the battery still does not rotate after charging or the battery is not good, Please contact the distributor where you made the purchase.

Declaration of Conformity

The product satisfies the provision for CE-marking according to the following directives:

- 1) **EMC Directive 2014/30/EU**
- 2) **Noise Directive 2000/14/EC**
- 3) **Machinery Directive 2006/42/EC**
- 4) **RoHS Directive 2011/65/EU**

Standards conform to:

EN62841-1
EN62841-2-2
EN55014-1
EN55014-2
EN61000-3-2
EN61000-3-3
EN62321 series

Date: 17/06/2020

Signature:

Naoya Kurachi
Plant Manager

A handwritten signature in black ink, appearing to read 'Naoya Kurachi', is written over a large, light gray 'CE' marking. The signature is written in a cursive style.

VESSEL application service team will gladly answer questions concerning our products and their accessories.

Manufacturer: VESSEL Co., Inc.

17-25 Fukaekita 2-Chome Higashinari-ku, OSAKA 537-0001 JAPAN

Web site: www.vessel.co.jp/english E-mail: export@vessel.co.jp

Distributors:

See below for national distributors.

www.vessel.co.jp/english/distributors/

PRINTED IN JAPAN